

**USB oscilloscope  
User's Guide  
Version 3.00**



Copyright © 2004-2009 ETC s.r.o.

Thank you for choosing USB oscilloscope, a product of ETC s.r.o. We believe it will fulfill your expectations. In order to assure that we will be able to provide you with up-to-date information, please fill-out the registration form at the ETC website.

For any further information or consultations, please contact us via mail, phone or preferably e-mail on the following adress:

Address:

ETC s.r.o.  
Rosinská cesta 8  
010 08, Žilina  
Slovak Republic

Phone:

+421-41-5652687

Fax:

+421-41-5652687

Internet:

URL: <http://www.etc.eu>  
e-mail: [support@etc.eu](mailto:support@etc.eu) - technical support  
[sales@etc.eu](mailto:sales@etc.eu) - sales  
[info@etc.eu](mailto:info@etc.eu) - other information

## Contents

Package contents (M520 and M570 family) .....	9
Package contents (M774 oscilloscope) .....	9
Package contents (M595 oscilloscope) .....	9
Warranty conditions .....	9
Software License Agreement .....	9
Precautions (M520 and M570 series) .....	10
Precautions (M770 series) .....	10
Precautions (M595 oscilloscope) .....	11
1. Installation .....	13
1.1. Requirements .....	13
1.2. Hardware installation (M520 series and M574 oscilloscope) .....	13
1.3. Hardware installation (M774 oscilloscope) .....	13
1.4. Hardware installation (M595 oscilloscope) .....	14
1.5. Software installation .....	14
2. Hardware .....	15
2.1. Hardware description of the M570 family .....	15
2.1.1. Digital Shielding (DSH) .....	16
2.1.2. Trigger circuits .....	16
2.1.3. Data acquisition .....	18
2.2. Hardware description of the M520 family .....	19
2.2.1. Digital Shielding (DSH) .....	20
2.2.2. Trigger circuits .....	20
2.2.3. Data acquisition .....	22
2.3. Hardware description of the M770 family .....	23
2.3.1. Digital Shielding (DSH) .....	24
2.3.2. Trigger circuits .....	25
2.3.3. Data acquisition .....	27
2.4. Hardware description of the M595 oscilloscope .....	28
2.4.1. Digital Shielding (DSH) .....	28
2.4.2. Trigger circuits .....	29
2.4.3. Data acquisition .....	31
3. Basic information .....	33
3.1. Front and rear panel layout .....	33
3.1.1. Front panel layout .....	33
3.1.2. M770 series rear panel layout .....	33
3.1.3. M595 oscilloscope rear panel layout .....	34
3.2. Basic terms .....	34
4. Main window .....	35
4.1. Main window in classic view .....	36
4.1.1. Oscilloscope screen .....	36
4.1.2. Quickview .....	38
4.1.3. Cursors and grid controls .....	38
4.1.4. Channel display controls .....	39
4.1.5. Save/load controls .....	40
4.1.6. Zoom controls .....	41
4.1.7. Timebase controls .....	42
4.1.8. Trigger mode controls .....	43

4.1.9. Trigger controls.....	44
4.1.10. Vertical range controls.....	46
4.1.11. Vertical shifts controls.....	46
4.1.12. Signal source controls.....	47
4.1.13. Channel information.....	47
4.1.14. Special functions controls.....	48
4.1.15. Fading controls.....	48
4.2. Main window in simple view.....	49
4.2.1. Oscilloscope screen.....	50
4.2.2. Quickview.....	51
4.2.3. Channel display controls.....	52
4.2.4. Special functions controls.....	52
4.2.5. Zoom controls.....	53
4.2.6. Timebase controls.....	53
4.2.7. Channel controls.....	54
4.2.8. Trigger controls.....	54
4.2.9. Channel information.....	55
4.3. Main menu.....	56
4.3.1. Options.....	56
4.3.2. Manage exports as ASCII window.....	59
4.3.3. Manage exports as image window.....	61
4.3.4. Hotkeys window.....	62
5. Other functions.....	64
5.1. Print Support.....	64
5.1.1. Setting the name of a new layout.....	66
5.1.2. Layout Manager.....	66
6. Special functions.....	68
6.1. 80% function (80%).....	68
6.2. Channel difference function (A-B).....	68
6.3. Channel add function (A+B).....	68
6.4. Channel A inversion (-A).....	68
6.5. Channel B inversion (-B).....	68
6.6. Channel A voltage inversion (-VA).....	68
6.7. Channel B voltage inversion (-VB).....	68
6.8. X-Y function (X/Y).....	69
6.9. Fourier transformation function (FT).....	70
6.9.1. Main menu.....	72
6.9.2. Complex filter window.....	74
6.10. Inverse fourier transformation function (IFT).....	75
6.11. Waveform parameters function (Wp).....	75
6.11.1. – Main menu.....	77
6.12. Phase shift calculation (Pf).....	77
7. Performance characteristics.....	79
7.1. M570 series performance characteristics.....	79
7.1.1. Vertical deflection system.....	79
7.1.2. Triggering.....	79
7.1.3. Data acquisition system.....	80
7.1.4. Probe compensation generator.....	80
7.1.5. Power.....	80
7.1.6. Mechanical characteristics.....	80

7.1.7. M574 timebase ranges .....	80
7.2. M520 series performance characteristics.....	81
7.2.1. Vertical deflection system.....	81
7.2.2. Triggering .....	82
7.2.3. Data acquisition system .....	82
7.2.4. Probe compensation generator .....	83
7.2.5. Power .....	83
7.2.6. Mechanical characteristics .....	83
7.2.7. M521 timebase ranges .....	83
7.2.8. M522 timebase ranges .....	84
7.2.9. M523 timebase ranges .....	84
7.2.10. M524 timebase ranges .....	85
7.2.11. M525 timebase ranges .....	86
7.2.12. M526 timebase ranges .....	86
7.3. M770 series performance characteristics.....	87
7.3.1. Vertical deflection system.....	87
7.3.2. Triggering .....	87
7.3.3. Data acquisition system .....	88
7.3.4. Probe compensation generator .....	88
7.3.5. Power .....	88
7.3.6. Insulation specification .....	88
7.3.7. Mechanical characteristics .....	89
7.3.8. M774 timebase ranges .....	89
7.4. M595 performance characteristics.....	89
7.4.1. Vertical deflection system.....	89
7.4.2. Triggering .....	90
7.4.3. Data acquisition system .....	90
7.4.4. Probe compensation generator .....	91
7.4.5. Synchronization output .....	91
7.4.6. Power .....	91
7.4.7. Mechanical characteristics .....	91
7.4.8. Timebase ranges of M595.....	92
8. Other information.....	93
8.1. .esb format.....	93
8.1.1. Block structure .....	93
8.1.2. Available information .....	94
8.2. Command lines parameters.....	97
8.2.1. Selecting settings loaded on the application start .....	97
8.2.2. Selecting the type of the used device .....	97

## Figures and tables

Fig. 2.1.2.1. – Block schematics of trigger circuits .....	16
Fig. 2.1.2.2. – Examples of trigger events (all inputs are enabled) .....	17
Fig. 2.1.3.1. – Simplified block schematics of the data acquisition .....	18
Fig. 2.2.2.1. – Block schematics of trigger circuits .....	20
Fig. 2.2.2.2. – Examples of trigger events (all inputs are enabled) .....	21
Fig. 2.2.3.1. – Simplified block schematics of the data acquisition .....	23
Fig. 2.3.2.1. – Block schematics of trigger circuits .....	25
Fig. 2.3.2.2. – Examples of trigger events (all inputs are enabled) .....	26
Fig. 2.3.3.1. – Simplified block schematics of the data acquisition .....	27
Fig. 2.4.2.1. – Block schematics of trigger circuits .....	29
Fig. 2.4.2.2. – Examples of trigger events (all inputs are enabled) .....	30
Fig. 2.4.3.1. – Simplified block schematics of the data acquisition .....	31
Fig. 3.1.1.1. – Front panel of the M570 series oscilloscope .....	33
Fig. 3.1.1.2. – Front panel of the M520 series oscilloscope .....	33
Fig. 3.1.1.3. – Front panel of the M770 series oscilloscope .....	33
Fig. 3.1.2.1. – M770 series rear panel layout.....	34
Fig. 3.1.3.1. – M595 rear panel layout.....	34
Fig. 4.1. – View mode selection .....	35
Fig. 4.1.1. – Main window in classic view .....	36
Fig. 4.1.1.1. – Oscilloscope screen .....	37
Fig. 4.1.2.1. – Quickview.....	38
Fig. 4.1.3.1. – The cursors and grid controls .....	39
Fig. 4.1.4.1. – Channel display controls .....	39
Fig. 4.1.5.1. – Save/load controls.....	40
Fig. 4.1.5.2. – Load controls .....	40
Fig. 4.1.5.3. – Save controls.....	41
Fig. 4.1.6.1. – Zoom controls.....	41
Fig. 4.1.7.1. – Timebase controls.....	42
Fig. 4.1.8.1. – Trigger mode controls .....	43
Fig. 4.1.8.2. – Trigger mode controls with separate hold controls .....	44
Fig. 4.1.9.1. – Trigger controls .....	44
Fig. 4.1.9.2. – Trigger source controls.....	44
Fig. 4.1.9.3. – After trigger amount controls .....	45
Fig. 4.1.9.4. – Hold-off controls .....	45
Fig. 4.1.10.1. – Range controls .....	46
Fig. 4.1.11.1. – Vertical shift controls .....	46
Fig. 4.1.12.1. – Signal source controls.....	47
Fig. 4.1.13.1. – Channel information .....	47
Fig. 4.1.14.1. – Special functions controls.....	48
Fig. 4.1.15.1. – Fading controls .....	49
Fig. 4.2.1. – Main window in simple view .....	50
Fig. 4.2.1.1. – Oscilloscope screen .....	50
Fig. 4.2.2.1. – Quickview.....	52
Fig. 4.2.3.1. – Channel display controls .....	52
Fig. 4.2.4.1. – Special functions controls.....	52
Fig. 4.2.5.1. – Zoom controls.....	53
Fig. 4.2.6.1. – Timebase controls.....	53

Fig. 4.2.7.1. – Channel controls .....	54
Fig. 4.2.8.1. – Trigger controls .....	54
Fig. 4.1.13.1. – Channel information .....	55
Fig. 4.3.1.1. – Options window .....	57
Fig. 4.3.2.1. – Manage exports as ASCII window .....	60
Fig. 4.3.3.1. – Manage exports as image window .....	61
Fig. 4.3.4.1. – The hotkeys window .....	63
Fig. 5.1.1. - Print Manager Window .....	64
Fig. 5.1.2. - Object Info.....	65
Fig. 5.1.3. - List of available objects.....	65
Fig. 5.1.1.1. - Specify Layout Name Window .....	66
Fig. 5.1.2.1. - Layout Manager Window.....	67
Fig. 6.8.1. – X-Y function window .....	69
Fig. 6.9.1. – Fourier transformation window .....	70
Fig. 6.9.2. – Status panel.....	71
Fig. 6.9.3. – Information about harmonic selected by cursor .....	71
Fig. 6.9.4. – Screen controls .....	72
Fig. 6.9.2.1. – Complex filter window .....	74
Fig. 6.9.2.2. – Selected frequency controls.....	75
Fig. 6.9.2.3. – Frequencies controls .....	75
Fig. 6.9.2.4. – New frequency window .....	75
Fig. 6.11.1. – Waveform parameters window .....	76
Fig. 6.12.1. – Phase shift window .....	78
Table 7.1.1.1. – Vertical deflection system .....	79
Table 7.1.2.1. – Triggering .....	79
Table 7.1.3.1. – Data acquisition system .....	80
Table 7.1.4.1. – Compensation generator .....	80
Table 7.1.5.1. - Power .....	80
Table 7.1.6.1. – Mechanical characteristics .....	80
Table 7.1.7.1. – M574 timebase ranges .....	81
Table 7.2.1.1. – Vertical deflection system .....	82
Table 7.2.2.1. – Triggering .....	82
Table 7.2.3.1. – Data acquisition system .....	83
Table 7.2.4.1. – Compensation generator .....	83
Table 7.2.5.1. - Power .....	83
Table 7.2.6.1. – Mechanical characteristics .....	83
Table 7.2.7.1. – M521 timebase ranges .....	84
Table 7.2.8.1. – M522 timebase ranges .....	84
Table 7.2.9.1. – M523 timebase ranges .....	85
Table 7.2.10.1. – M524 timebase ranges .....	85
Table 7.2.11.1. – M525 timebase ranges .....	86
Table 7.2.12.1. – M526 timebase ranges .....	87
Table 7.3.1.1. – Vertical deflection system .....	87
Table 7.3.2.1. – Triggering .....	88
Table 7.3.3.1. – Data acquisition system .....	88
Table 7.3.4.1. – Compensation generator .....	88
Table 7.3.5.1. – Power .....	88
Table 7.3.6.1. – Insulation specification .....	89
Table 7.3.7.1. – Mechanical characteristics .....	89
Table 7.3.8.1. – M774 timebase ranges .....	89

Table 7.4.1.1. – Vertical deflection system .....	90
Table 7.4.2.1. – Triggering .....	90
Table 7.4.3.1. – Data acquisition system .....	91
Table 7.4.4.1. – Probe compensation generator .....	91
Table 7.1.5.1. - Power .....	91
Table 7.4.6.1. – Mechanical characteristics .....	91
Table 7.4.10.1. –M595 timebase ranges .....	92
Table 8.2.2.1. – Allowed device types of –d parameter .....	97



### **Package contents (M520 and M570 family)**

- USB oscilloscope – 1pc
- USB cable – 1pc
- installation leaflet – 1pc
- CD with software and user's guide in pdf – 1pc

### **Package contents (M774 oscilloscope)**

- USB oscilloscope – 1pc
- USB cable – 1pc
- Safety grounding cable – 1pc
- installation leaflet – 1pc
- CD with software and user's guide in pdf – 1pc

### **Package contents (M595 oscilloscope)**

- USB oscilloscope – 1pc
- USB cable – 1pc
- power adaptor
- installation leaflet – 1pc
- CD with software and user's guide in pdf – 1pc

### **Warranty conditions**

The ETC s.r.o. company guarantees reliable operation of the oscilloscope in compliance with this documentation during a period of 24 months from the date of purchase.

Should a malfunction occur during the warranty period, excluding errors for which ETC can not be held responsible, ETC guarantees the repair of the product or its replacement with a new or repaired one free of charge.

The ETC company shall not be responsible for malfunctions on the device caused by an accident, incorrect manipulation, unauthorized interventions or similar.

When requesting the warranty service, the customer should send the device in its original package to the dealer from whom it was purchased or directly to the ETC company. The warranty certificate together with a description of the defect or malfunction should be included in the package. The customer agrees that a new or repaired product to be shipped would be insured against damage or loss during the transport and that he will cover the costs for the shipment and insurance.

### **Software License Agreement**

This legal document is an agreement between you, the end user, and ETC s.r.o. By installing this product on your computer, you are agreeing to become bound by the terms of this agreement and warranty conditions.

1. GRANT OF LICENSE. ETC s.r.o. as Licensor, grants you, the Licensee, a nonexclusive right to use and display this copy of the Scope software (hereinafter the

"SOFTWARE"), device and accompanying written materials, on a single COMPUTER at a single location and only together so long as you comply with the terms of this License.

2. OWNERSHIP. As the LICENSEE, you own the magnetic or other physical media on which the SOFTWARE is originally or subsequently recorded or fixed, but an express condition of this License is that ETC s.r.o. retains title and ownership of the SOFTWARE recorded on the original disk copy(ies) and all subsequent copies of the software, regardless of the form or media in or on which the original and other copies may exist. This License is not a sale of the original SOFTWARE or any copy.

3. COPY RESTRICTIONS. This SOFTWARE, device and accompanying written materials are copyrighted. Unauthorized copying or copy attempt of the device, including module which has been modified or included with any other system, or of written materials is expressly forbidden. It is, however, allowed to pass SOFTWARE on as the DEMO version. You may be held legally responsible for any copyright infringement which is caused or encouraged by your failure to abide by the terms of this License.

4. DISCLAIMER OF THE WARRANTY OF ANY KIND CONCERNING SOFTWARE. This SOFTWARE and accompanying written materials are provided "AS IS" without a warranty of any kind. Further, ETC s.r.o. does not warrant, guarantee or make any representations regarding the use, or the results of use, of the SOFTWARE, device or written materials in terms of correctness, accuracy, reliability, currentness, or otherwise. The entire risk as to the results and performance of the software is assumed by you.

## **Precautions (M520 and M570 series)**

Please follow these recommendations to avoid any possible problems that might occur while using the oscilloscope of M520 or M570 series:

- read the User's Guide
- always connect device using cable, which is the part of package. If it is not possible, always use USB 2.0 cable.
- never connect signal with absolute voltage higher than 200V to measuring inputs. This value is valid for frequencies lower than 100kHz. Over this frequency, the voltage lowers with raising frequency. For example frequency 200kHz of 100V, 400kHz of 50V is the limit. However we do not recommend to connect voltage higher than 50V, because touching it can be dangerous for health.
- never connect voltage lower than -10V and higher than +13V to the external triggering input (frequency lower than 20kHz). Over 20kHz, voltage lower than -0.5V or higher than +4V is not recommended.
- never connect voltage to the oscilloscope ground, it may result in device or computer damage
- never disassemble device, since there are no user serviceable parts inside
- always use device in indoor laboratory environment
- never integrate device into any other system

## **Precautions (M770 series)**

Please follow these recommendations to avoid any possible problems that might occur while using the oscilloscope:

- read the User's Guide

- always connect device using USB cable, which is the part of the package.
- never connect voltage higher than 200Vp between the measuring ground and the input. This value is valid for frequencies lower than 100 kHz. Over this frequency, the voltage lowers with rising frequency. For example voltage of 100Vp with frequency 200 kHz is the limit. You can always connect voltage with peak value up to 4 times the input range set (32 time the sensitivity in v/div) independent on frequency.
- never connect voltage lower than -10V and higher than +13V to the external triggering input (frequency lower than 20 kHz). Over 20 kHz, voltage lower than -0.5V or higher than +4V is not recommended.
- the measuring ground is common for all of the measuring connectors. The voltage connected to one of these grounds appears also on the rest two of them. Do not connect different voltages to the grounds of the measuring connectors. It can destroy the measuring instrument and/or the measured device.
- when the voltage above 50V is connected to one of the measuring connector's ground, touching the rest of two of them can be dangerous for your health.
- when you connect the voltage higher then 50V to the measuring ground, please be sure, that the instrument is dry. If you brought the instrument from the colder environment please wait until it warms up to the temperature of the new environment.
- when the voltage higher than 50V is connected to the measuring ground, for safety reasons we recommend connect the chassis ground of the instrument (connector on the back side of the instrument) to the ground of the environment (i.e. main's ground, water pipe, etc...). The grounding cable is in the standard package.
- do not connect voltage higher than 500 Vp to the measuring ground. Also the  $V * Hz$  factor should be lower than 50000. For example if the voltage is 500V its frequency should be lower than 100 Hz.
- never disassemble the device, since there are no user serviceable parts inside.
- always use device in indoor laboratory environment
- never integrate device into any other system

## **Precautions (M595 oscilloscope)**

Please follow these recommendations to avoid any possible problems that might occur while using the oscilloscope of M595:

- read the User's Guide
- always connect device using cable, which is the part of package. If it is not possible, always use USB 2.0 cable.
- never connect signal with absolute voltage higher than 200V to measuring inputs. This value is valid for frequencies lower than 100kHz. Over this frequency, the voltage lowers with raising frequency. For example frequency 200kHz of 100V, 400kHz of 50V is the limit. However we do not recommend to connect voltage higher than 50V, because touching it can be dangerous for health.
- never connect voltage lower than -10V and higher than +13V to the external triggering input (frequency lower than 20kHz). Over 20kHz, voltage lower than -0.5V or higher than +4V is not recommended.
- never connect voltage to the oscilloscope ground, it may result in device or computer damage
- never disassemble device, since there are no user serviceable parts inside
- always use device in indoor laboratory environment
- never integrate device into any other system

- always use the power adapter from the package. If it is not possible, always use power supply with 10 to 18VDC with min 7W output power with 2.1/5.5 central + DC connector.
- be sure, that free air flow is possible on the bottom side of the instrument. In other case the cooling of the instrument's circuitry would be impossible.

## 1. Installation

### 1.1. Requirements

Minimum configuration:

- PC PENTIUM compatible computer
- 64MB RAM
- CD-ROM
- VGA with resolution 800 x 600
- USB port 1.1
- mouse or other tracking device
- at least 20MB free space on the hard drive
- MS Windows 98 SE, ME, 2000 or XP

Recommended configuration:

- PC PENTIUM compatible computer with speed of at least 800MHz
- 256MB RAM
- CD-ROM
- VGA with resolution at least 1024x768
- USB port 2.0
- mouse or other tracking device
- at least 20MB free space on the hard drive
- MS Windows 98 SE, 2000 or XP

### 1.2. Hardware installation (M520 series and M574 oscilloscope)

Connect one side of the cable to the computer, other one to the device. Proceed with the software installation.

---

**WARNING: Always use cable, which is the part of the package. Usage of the improper cable can disable communication with the computer.**

---

### 1.3. Hardware installation (M774 oscilloscope)

Connect one side of the cable to the computer, other one to the device. Proceed with the software installation.

If the device is grounded to the voltage higher than 50V, we recommend (due to safety reasons) to ground the device chassis using the enclosed cable.

---

**WARNING: Always use cable, which is the part of the package. Usage of the improper cable can disable communication with the computer.**

---

## 1.4. Hardware installation (M595 oscilloscope)

Connect one side of the USB cable to the computer, other one to the device. Connect the output of the power adapter to the power input of the device. Plug the adapter to main's outlet. Proceed with the software installation.

---

**WARNING: Always use cable, which is the part of the package. Usage of the improper cable can disable communication with the computer.**

---

## 1.5. Software installation

The software and the device drivers are located on the enclosed CD. Insert the CD into the CD-ROM drive. Then follow the instructions of the setup program that should launch automatically. If the CD autorun is not enabled in your computer's settings, please run file *autorun.exe* from the CD.

## 2. Hardware

The information contained in this chapter will help you to understand the features of your oscilloscope.

### 2.1. Hardware description of the M570 family

The M570 series of dual channel digital storage USB oscilloscopes connect to the computer via USB. They are compatible with both USB 2.0 and USB 1.1. Measurement accuracy is achieved by the stability of the parts used together with the computing power of the computer. Calibration data are part of the HW, which makes it impossible to lose them (opposite to the calibration data located on the diskette). Therefore, it is possible to simply connect the hardware to any computer (via USB 1.1 or USB 2.0 interface). All you have to do is just installing the software.

The M570 series oscilloscopes allow user to measure waveforms using two independent channels with resolution of 8 bits and sensitivity from 10mV/div to 5V/div (80mVfs to 40Vfs) in 9 steps. One division of the oscilloscope screen contains 32 dots. Input impedance matches the oscilloscope standards therefore any regular oscilloscope probe (with minimum compensation range of 32pF) can be connected to the device. The software supports 1:1, 1:10, 1:100 and 1:1000 probes. AC or DC coupling and type of probe can be independently selected for each vertical channel. Any of the inputs can be grounded without disconnecting the probes from the measured system. Vertical track position can be controlled with accuracy of 1 pixel of the oscilloscope screen. Measurement can be triggered from the Channel A, Channel B and/or External trigger input. Trigger threshold can be set independently for each channel in the range of whole oscilloscope screen with resolution of one pixel. Threshold of the External trigger input is fixed to about 1.5V (TTL and CMOS compatible). The M570 series oscilloscopes have the dual level triggering system, which is closely described in chapter 2.1.2. Oscilloscope hardware offers data acquisition with maximum rate of 50, 100 or 200MS/s depending on the model. Therefore it is not possible to sample non-repetitive waveforms faster than every 20, 10 or 5ns (depending on the model). However, thanks to random sampling method, it is possible to sample repetitive waveforms with period of 200, 100 or 50ps (depending on the model), which corresponds with equivalent sampling rate of 5, 10 or 20GS/s. For displaying waveforms acquired using the random sampling method, the ETC company has developed system called WCD (Waveform Conformity Detection), which speeds up display of changes of measured waveform.

The oscilloscope hardware can acquire data in one universal mode.

- **Acquiring data before and after trigger with settable trigger position** displays waveform before and/or after trigger. The position of the trigger is settable by the user. In this mode the hardware of the oscilloscope starts data acquisition immediately after the start of measurement. The trigger event terminates the data acquisition after collection the data amount set by the user. The trigger position can be set to any place between these margins. The "Hold Off" timer allows the user to prevent the occurrence of a trigger event after the start of data acquisition. This feature allows to acquire proper amount of data before the trigger.

Each measuring channel of the M570 series oscilloscopes has its own AD converter. No channel multiplexing is used for dual channel operation.

### 2.1.1. Digital Shielding (DSH)

Digital Shielding removes interference asynchronous with the measured signal, and it does not affect frequency characteristics of the measured waveform. The only negative effect of DSH is longer time period of waveform stabilization. It is, however, very simple to turn the DSH off using the on-screen controls. The DSH efficiency level corresponds to DSH level factor that can be set to any value from 2 to 64. The higher the level you choose, the longer it takes to stabilize.

### 2.1.2. Trigger circuits

The block schematics of the dual level trigger circuits are shown on the figure 2.1.2.1.

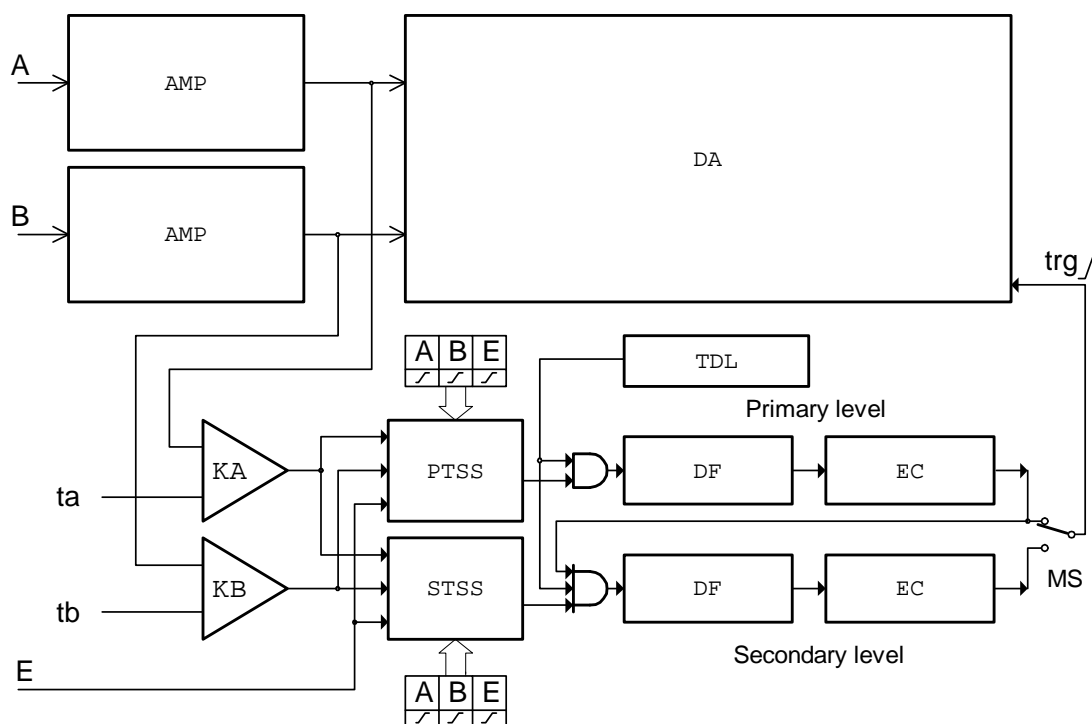



















**Fig. 2.1.2.1. – Block schematics of trigger circuits**

Data for trigger circuits come either from Channel A, Channel B or from external trigger input (E). The comparators KA and KB produce binary signals for Primary Trigger Source Selector (PTSS) and Secondary Trigger Source Selector (STSS) while the threshold of each comparator (ta, tb) can be set to any value in the vertical range. If the actual output voltage of the channel is higher than the actual threshold the output of comparator is set to 1 (TRUE). If it is lower than the threshold, the output will be 0 (FALSE). The Trigger Source Selectors for each triggering level are independent. It is possible to select the source of triggering signal for each level independently. In addition to source selection, the PTSS and STSS can invert any of the input signal. The trigger event is generated with respect to change of the selector (PTSS, STSS) output signal from 0 (FALSE) to 1 (TRUE). Constant level of the



signal cannot start the measurement. In case that only one of the signals is selected, trigger event is generated corresponding to the polarity, which is symbolically presented by direction of change of the signal. (0 to 1 means no inversion). When there are several inputs selected, the selector makes a logical addition (OR) of all of the selected inputs. Before adding the signals together, ones are adjusted with respect to the polarity settings. Trigger event is generated only when the change of result of the logical addition occurred from 0 to 1 (FALSE to TRUE). Logical values of the signals in the input of logical adder (OR) from which the trigger event is generated are created on the basis of following rules: value 0 (FALSE) is the value that selector input signal should have before valid trigger event. 1 (TRUE) is the value that this signal will have after the valid trigger event. For example, if triggering from Channel A is set to the trailing edge, then the output voltage of the channel is higher than the threshold voltage, consequent value on the adder input will be 0 (FALSE). Inverse situation will be taken as 1 (TRUE). Note that when using logical addition, all values must be 0 (FALSE) in order for result to be 0 (FALSE). It is relatively easy to find out which are the valid trigger events. Figure 2.1.2.2 shows several valid and invalid trigger events (all inputs are enabled).

			selected trigger event
A	B	E	
			valid
			invalid
			invalid
			valid
			valid

**Fig. 2.1.2.2. – Examples of trigger events (all inputs are enabled)**

The digital pulse filters (DF) are implemented in both primary and secondary trigger levels. If activated, they filter out pulses shorter than the value  $4 \cdot N \cdot T_s$ , where  $T_s$  is the actual real time sampling period and  $N$  is the value set by the user ( $1 \leq N \leq 32767$ ). If we want to use this option it is necessary to set the valid trigger event to the end of the pulse. For example, if the pulse we want to filter off is positive (0 to 1 to 0) the trigger event should be set to trailing edge (1 to 0). If the pulse is inverse (1 to 0 to 1), the trigger event should be set to leading edge (1 to 0). The outputs of digital pulse filters are connected to event counters (EC). It counts the unfiltered pulses. If the MS switch is set to primary level, the output of primary event counter will change from 0 (FALSE) to 1 (TRUE) to indicate the valid trigger event after reaching the terminal count, which is user settable in the range of 1 to 32767. If the MS switch is set to secondary level, the output of primary event counter activates the secondary trigger level. The input selector, digital filter and event counter can be set for secondary level independently to define the valid trigger event.

The trigger circuits of the series M570 DSOs are equipped with Hold Off timer (TDL). It blocks the triggering event for time period  $T=4 \cdot H \cdot T_s$  from the start of data acquisition, where  $T_s$  is the actual real time sampling period and  $H$  is the user

selectable value from 0 to 32767. It is important to set the proper value H to ensure that the hardware of the oscilloscope acquires proper amount of data before trigger event. For example, if we want to display waveform for time period of  $T_z$  before the trigger it is necessary to set  $T \geq T_z$  to ensure that all of the data will be displayed.

The M570 series oscilloscopes have four triggering modes implemented:

**AUTO** – Data acquisition is triggered by a valid trigger event. However, when after certain time the trigger event does not occur, measurement starts.

**NORMAL** – Data acquisition is triggered by a valid trigger event.

**SINGLE** – Data acquisition starts after activation from the control panel and it is synchronized by the valid trigger event. Just one measuring cycle is executed.

**MANUAL** – One measuring cycle is executed immediately after activation from the control panel.

### 2.1.3. Data acquisition

The simplified block schematics of data acquisition is shown on Figure 2.1.3.1.

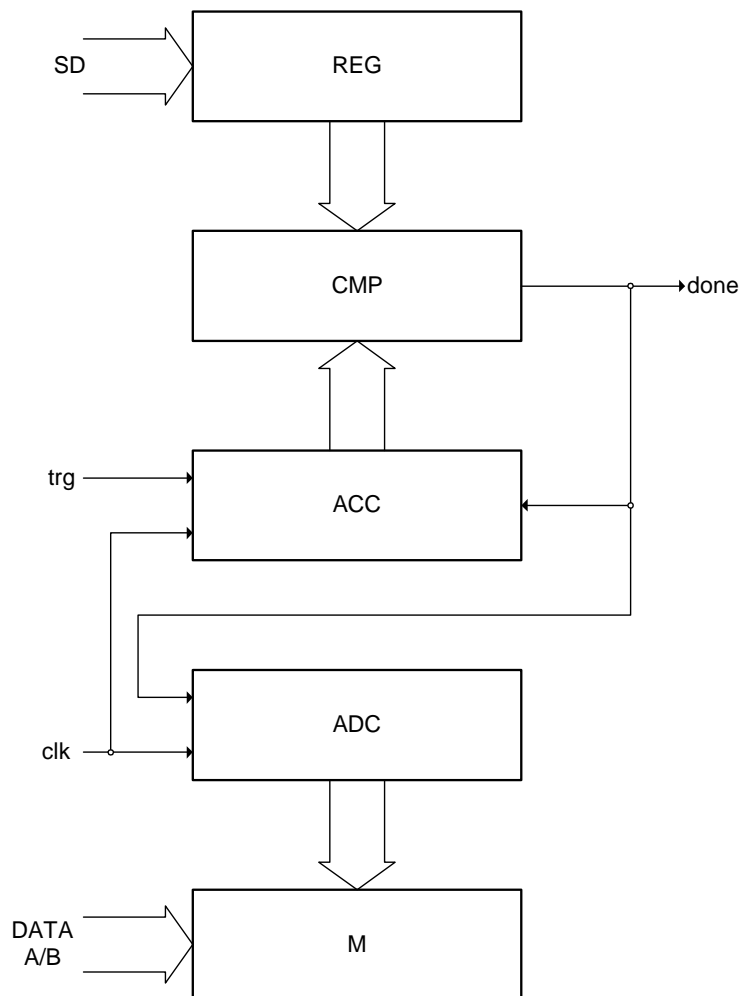

**Fig. 2.1.3.1. – Simplified block schematics of the data acquisition**

The data from AD converters are stored in the onboard memory M. This memory is addressed by address counter ADC, which starts to count immediately after start of measurement, regardless of trigger event. The occurrence of valid trigger event starts the after trigger data counter (ACC). Comparator CMP compares the state of ACC with the output of register (REG), which contains data amount acquired after trigger. When the output of ACC reaches the value written to REG, the comparator produces the signal (done), which stops both the ADC and ACC counters. The amount of data written after trigger to memory depends on the value of REG. The value written to REG controls the relation of the trigger event and the displayed data. Changing the value of REG it is possible to display data before, before and after or only after trigger.

## 2.2. Hardware description of the M520 family

The M520 series of dual channel digital storage USB oscilloscopes connect to the computer via USB. They are compatible with both USB 2.0 and USB 1.1. Measurement accuracy is achieved by the stability of the parts used together with the computing power of the computer. Calibration data are part of the HW, which makes it impossible to lose them (oppose to the calibration data located on the diskette). Therefore, it is possible to simply connect the hardware to any computer (via USB 1.1 or USB 2.0 interface). All you have to do is just installing the software.

The M520 series oscilloscopes allow user to measure waveforms using two independent channels with resolution of 8 bits and sensitivity from 10mV/div to 5V/div (80mVfs to 40Vfs) in 9 steps. One division of the oscilloscope screen contains 32 dots. Input impedance matches the oscilloscope standards therefore any regular oscilloscope probe (with minimum compensation range of 32pF) can be connected to the device. The software supports 1:1, 1:10, 1:100 and 1:1000 probes. AC or DC coupling and type of probe can be independently selected for each vertical channel. Any of the inputs can be grounded without disconnecting the probes from the measured system. Vertical track position can be controlled with accuracy of 1 pixel of the oscilloscope screen. Measurement can be triggered from the Channel A, Channel B and/or External trigger input. Trigger threshold can be set independently for each channel in the range of whole oscilloscope screen with resolution of one pixel. Threshold of the External trigger input is fixed to about 1.5V (TTL and CMOS compatible). The M520 series oscilloscopes have the dual level triggering system, which is closely described in chapter 2.1.2. Oscilloscope hardware offers data acquisition with maximum rate of 50, 100 or 200MS/s depending on the model. Therefore it is not possible to sample non-repetitive waveforms faster than every 20, 10 or 5ns (depending on the model). However, thanks to random sampling method, it is possible to sample repetitive waveforms with period of 200, 100 or 50ps (depending on the model), which corresponds with equivalent sampling rate of 5, 10 or 20GS/s. For displaying waveforms acquired using the random sampling method, the ETC company has developed system called WCD (Waveform Conformity Detection), which speeds up display of changes of measured waveform.

The oscilloscope hardware can acquire data in one universal mode.

- **Acquiring data before and after trigger with settable trigger position** displays waveform before and/or after trigger. The position of the trigger is settable by the user. In this mode the hardware of the oscilloscope starts data acquisition

immediately after the start of measurement. The trigger event terminates the data acquisition after collection the data amount set by the user. Number of data acquired after trigger can be set from two to over 63000 samples. This is much more than the capacity of onboard data buffer. This feature allows to display waveform corresponding with capacity of onboard storage (4KS or 8KS for each channel depending on the model) before the trigger or waveforms after trigger delayed from the occurrence of trigger up to 63000 samples in the length of capacity of onboard storage. The trigger position can be set to any place between these margins. The “Hold Off” timer allows the user to prevent the occurrence of a trigger event after the start of data acquisition. This feature allows to acquire proper amount of data before the trigger.

Each measuring channel of the M520 series oscilloscopes has its own AD converter. No channel multiplexing is used for dual channel operation.

### 2.2.1. Digital Shielding (DSH)

Digital Shielding removes interference asynchronous with the measured signal, and it does not affect frequency characteristics of the measured waveform. The only negative effect of DSH is longer time period of waveform stabilization. It is, however, very simple to turn the DSH off using the on-screen controls. The DSH efficiency level corresponds to DSH level factor that can be set to any value from 2 to 64. The higher the level you choose, the longer it takes to stabilize.

### 2.2.2. Trigger circuits

The block schematics of the dual level trigger circuits are shown on the figure 2.2.2.1.

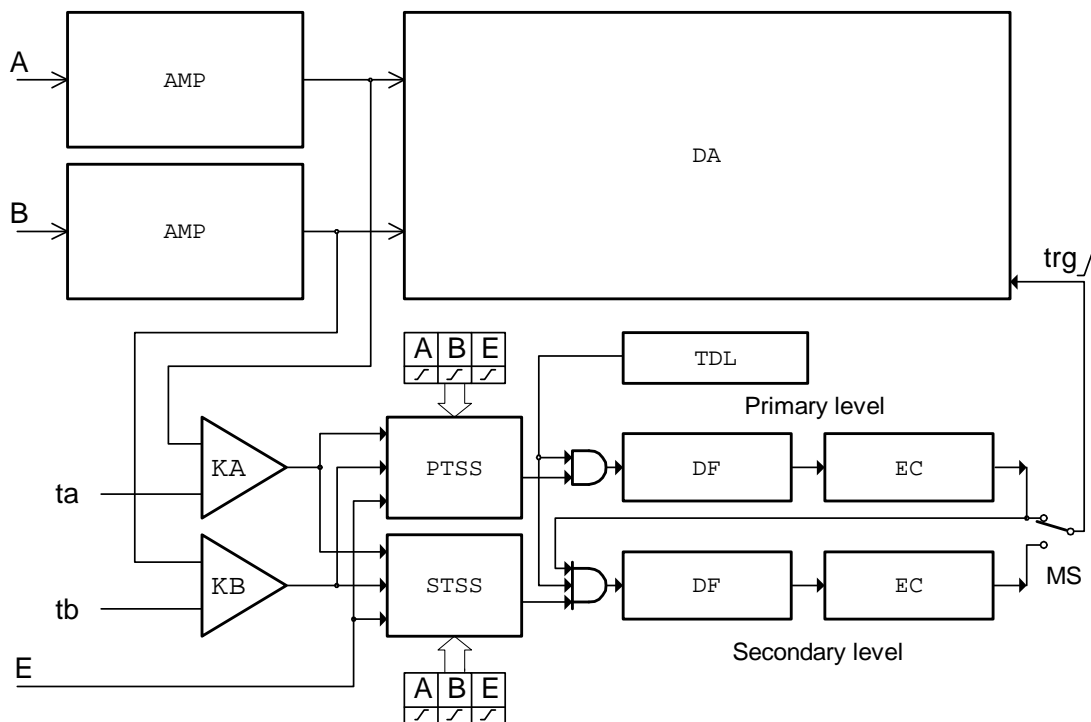



















Fig. 2.2.2.1. – Block schematics of trigger circuits

Data for trigger circuits come either from Channel A, Channel B or from external trigger input (E). The comparators KA and KB produce binary signals for Primary Trigger Source Selector (PTSS) and Secondary Trigger Source Selector (STSS) while the threshold of each comparator (ta, tb) can be set to any value in the vertical range. If the actual output voltage of the channel is higher than the actual threshold the output of comparator is set to 1 (TRUE). If it is lower than the threshold, the output will be 0 (FALSE). The Trigger Source Selectors for each triggering level are independent. It is possible to select the source of triggering signal for each level independently. In addition to source selection, the PTSS and STSS can invert any of the input signal. The trigger event is generated with respect to change of the selector (PTSS, STSS) output signal from 0 (FALSE) to 1 (TRUE). Constant level of the signal cannot start the measurement. In case that only one of the signals is selected, trigger event is generated corresponding to the polarity, which is symbolically presented by direction of change of the signal. (0 to 1 means no inversion). When there are several inputs selected, the selector makes a logical addition (OR) of all of the selected inputs. Before adding the signals together, ones are adjusted with respect to the polarity settings. Trigger event is generated only when the change of result of the logical addition occurred from 0 to 1 (FALSE to TRUE). Logical values of the signals in the input of logical adder (OR) from which the trigger event is generated are created on the basis of following rules: value 0 (FALSE) is the value that selector input signal should have before valid trigger event. 1 (TRUE) is the value that this signal will have after the valid trigger event. For example, if triggering from Channel A is set to the trailing edge, then the output voltage of the channel is higher than the threshold voltage, consequent value on the adder input will be 0 (FALSE). Inverse situation will be taken as 1 (TRUE). Note that when using logical addition, all values must be 0 (FALSE) in order for result to be 0 (FALSE). It is relatively easy to find out which are the valid trigger events. Figure 2.1.2.2 shows several valid and invalid trigger events (all inputs are enabled).

			selected trigger event
A	B	E	
			valid
			invalid
			invalid
			valid
			valid

**Fig. 2.2.2.2. – Examples of trigger events (all inputs are enabled)**

The digital pulse filters (DF) are implemented in both primary and secondary trigger levels. If activated, they filter out pulses shorter than the value  $4 \cdot N \cdot T_s$ , where  $T_s$  is the actual real time sampling period and  $N$  is the value set by the user ( $1 \leq N \leq 32767$ ). If we want to use this option it is necessary to set the valid trigger event to the end of the pulse. For example, if the pulse we want to filter off is positive (0 to 1 to 0) the trigger event should be set to trailing edge (1 to 0). If the pulse is inverse (1 to 0 to 1), the trigger event should be set to leading edge (1 to 0). The outputs of

digital pulse filters are connected to event counters (EC). It counts the unfiltered pulses. If the MS switch is set to primary level, the output of primary event counter will change from 0 (FALSE) to 1 (TRUE) to indicate the valid trigger event after reaching the terminal count, which is user settable in the range of 1 to 32767. If the MS switch is set to secondary level, the output of primary event counter activates the secondary trigger level. The input selector, digital filter and event counter can be set for secondary level independently to define the valid trigger event.

The trigger circuits of the series M520 DSOs are equipped with Hold Off timer (TDL). It blocks the triggering event for time period  $T=4*H*Ts$  from the start of data acquisition, where  $Ts$  is the actual real time sampling period and  $H$  is the user selectable value from 0 to 32767. It is important to set the proper value  $H$  to ensure that the hardware of the oscilloscope acquires proper amount of data before trigger event. For example, if we want to display waveform for time period of  $Tz$  before the trigger it is necessary to set  $T \geq Tz$  to ensure that all of the data will be displayed.

The M520 series oscilloscopes have four triggering modes implemented:

**AUTO** – Data acquisition is triggered by a valid trigger event. However, when after certain time the trigger event does not occur, measurement starts.

**NORMAL** – Data acquisition is triggered by a valid trigger event.

**SINGLE** – Data acquisition starts after activation from the control panel and it is synchronized by the valid trigger event. Just one measuring cycle is executed.

**MANUAL** – One measuring cycle is executed immediately after activation from the control panel.

### 2.2.3. Data acquisition

The simplified block schematics of data acquisition is shown on Figure 2.2.3.1.

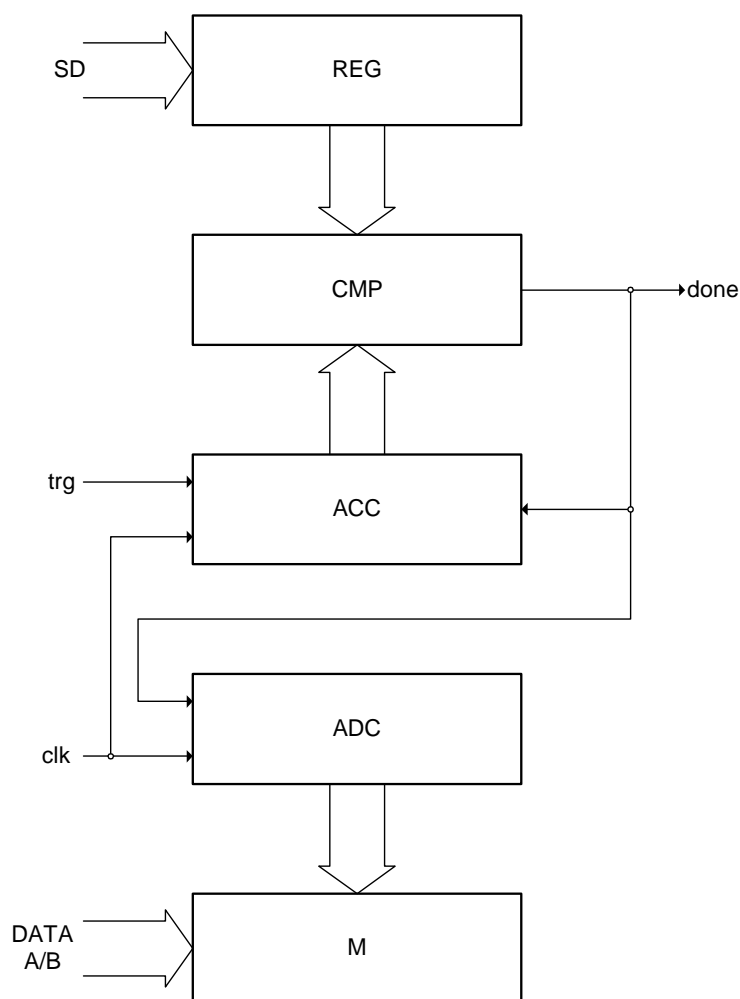

**Fig. 2.2.3.1. – Simplified block schematics of the data acquisition**

The data from AD converters are stored in the onboard memory M. This memory is addressed by address counter ADC, which starts to count immediately after start of measurement, regardless of trigger event. The occurrence of valid trigger event starts the after trigger data counter (ACC). Comparator CMP compares the state of ACC with the output of register (REG), which contains data amount acquired after trigger. When the output of ACC reaches the value written to REG, the comparator produces the signal (done), which stops both the ADC and ACC counters. The amount of data written after trigger to memory depends on the value of REG. The value written to REG controls the relation of the trigger event and the displayed data. Changing the value of REG it is possible to display data before, before and after or only after trigger. Because the length of the ACC counter is far more longer than the capacity of the onboard memory (more than 63000), it is possible to display data delayed from the trigger event more than the capacity of the onboard storage. However the length of displayed waveform is determined by the capacity of onboard memory. This structure of data acquisition creates the illusion of onboard memory with capacity determined by the length of ACC counter.

### **2.3. Hardware description of the M770 family**

The M770 series of dual channel digital storage USB oscilloscopes connect to the computer via USB. They are compatible with both USB 2.0 and USB 1.1.

Measurement accuracy is achieved by the stability of the parts used together with the computing power of the computer. Calibration data are part of the HW, which makes it impossible to lose them (opposite to the calibration data located on the diskette). Therefore, it is possible to simply connect the hardware to any computer (via USB 1.1 or USB 2.0 interface). All you have to do is just installing the software.

The common potential of measuring inputs (measuring ground) is isolated from the common potential (ground or chassis) of the host computer.

The M770 series oscilloscopes allow user to measure waveforms using two independent channels with resolution of 8 bits and sensitivity from 10mV/div to 5V/div (80mVfs to 40Vfs) in 9 steps. One division of the oscilloscope screen contains 32 dots. Input impedance matches the oscilloscope standards therefore any regular oscilloscope probe (with minimum compensation range of 32pF) can be connected to the device. The software supports 1:1, 1:10, 1:100 and 1:1000 probes. AC or DC coupling and type of probe can be independently selected for each vertical channel. Any of the inputs can be grounded without disconnecting the probes from the measured system. Vertical track position can be controlled with accuracy of 1 pixel of the oscilloscope screen. Measurement can be triggered from the Channel A, Channel B and/or External trigger input. Trigger threshold can be set independently for each channel in the range of whole oscilloscope screen with resolution of one pixel. Threshold of the External trigger input is fixed to about 1.5V (TTL and CMOS compatible). The M770 series oscilloscopes have the dual level triggering system, which is closely described in chapter 2.1.2. Oscilloscope hardware offers data acquisition with maximum rate of 50, 100 or 200MS/s depending on the model. Therefore it is not possible to sample non-repetitive waveforms faster than every 20, 10 or 5ns (depending on the model). However, thanks to random sampling method, it is possible to sample repetitive waveforms with period of 200, 100 or 50ps (depending on the model), which corresponds with equivalent sampling rate of 5, 10 or 20GS/s. For displaying waveforms acquired using the random sampling method, the ETC company has developed system called WCD (Waveform Conformity Detection), which speeds up display of changes of measured waveform.

The oscilloscope hardware can acquire data in one universal mode.

- **Acquiring data before and after trigger with settable trigger position** displays waveform before and/or after trigger. The position of the trigger is settable by the user. In this mode the hardware of the oscilloscope starts data acquisition immediately after the start of measurement. The trigger event terminates the data acquisition after collection the data amount set by the user. The trigger position can be set to any place between these margins. The "Hold Off" timer allows the user to prevent the occurrence of a trigger event after the start of data acquisition. This feature allows to acquire proper amount of data before the trigger.

Each measuring channel of the M770 series oscilloscopes has its own AD converter. No channel multiplexing is used for dual channel operation.

### 2.3.1. Digital Shielding (DSH)

Digital Shielding removes interference asynchronous with the measured signal, and it does not affect frequency characteristics of the measured waveform. The only negative effect of DSH is longer time period of waveform stabilization. It is, however, very simple to turn the DSH off using the on-screen controls. The DSH



efficiency level corresponds to DSH level factor that can be set to any value from 2 to 64. The higher the level you choose, the longer it takes to stabilize.

### 2.3.2. Trigger circuits



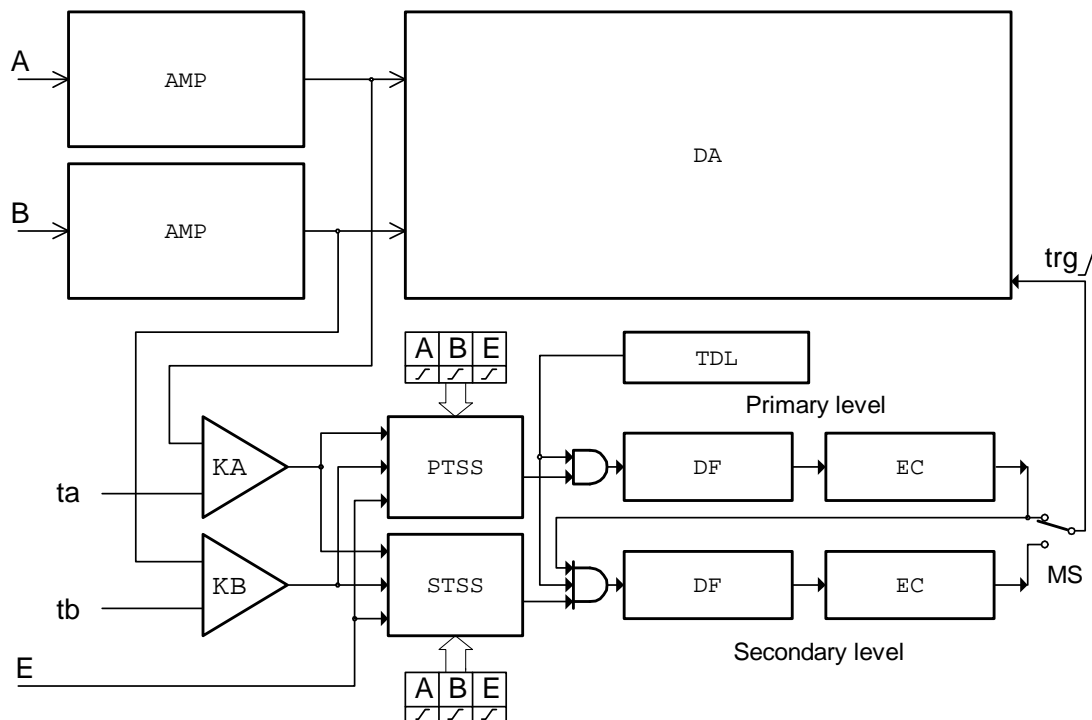















The block schematics of the dual level trigger circuits are shown on the figure 2.1.2.1.



**Fig. 2.3.2.1. – Block schematics of trigger circuits**

Data for trigger circuits come either from Channel A, Channel B or from external trigger input (E). The comparators KA and KB produce binary signals for Primary Trigger Source Selector (PTSS) and Secondary Trigger Source Selector (STSS) while the threshold of each comparator (ta, tb) can be set to any value in the vertical range. If the actual output voltage of the channel is higher than the actual threshold the output of comparator is set to 1 (TRUE). If it is lower than the threshold, the output will be 0 (FALSE). The Trigger Source Selectors for each triggering level are independent. It is possible to select the source of triggering signal for each level independently. In addition to source selection, the PTSS and STSS can invert any of the input signals. The trigger event is generated with respect to change of the selector (PTSS, STSS) output signal from 0 (FALSE) to 1 (TRUE). Constant level of the signal cannot start the measurement. In case that only one of the signals is selected, trigger event is generated corresponding to the polarity, which is symbolically presented by direction of change of the signal. (0 to 1 means no inversion). When there are several inputs selected, the selector makes a logical addition (OR) of all of the selected inputs. Before adding the signals together, ones are adjusted with respect to the polarity settings. Trigger event is generated only when the change of result of the logical addition occurred from 0 to 1 (FALSE to TRUE). Logical values of the signals in the input of logical adder (OR) from which the trigger event is generated are created on the basis of following rules: value 0 (FALSE) is the value that selector

input signal should have before valid trigger event. 1 (TRUE) is the value that this signal will have after the valid trigger event. For example, if triggering from Channel A is set to the trailing edge, then the output voltage of the channel is higher than the threshold voltage, consequent value on the adder input will be 0 (FALSE). Inverse situation will be taken as 1 (TRUE). Note that when using logical addition, all values must be 0 (FALSE) in order for result to be 0 (FALSE). It is relatively easy to find out which are the valid trigger events. Figure 2.1.2.2 shows several valid and invalid trigger events (all inputs are enabled).

			selected trigger event
A	B	E	
			valid
			invalid
			invalid
			valid
			valid

**Fig. 2.3.2.2. – Examples of trigger events (all inputs are enabled)**

The digital pulse filters (DF) are implemented in both primary and secondary trigger levels. If activated, they filter out pulses shorter than the value  $4 \cdot N \cdot T_s$ , where  $T_s$  is the actual real time sampling period and  $N$  is the value set by the user ( $1 \leq N \leq 32767$ ). If we want to use this option it is necessary to set the valid trigger event to the end of the pulse. For example, if the pulse we want to filter off is positive (0 to 1 to 0) the trigger event should be set to trailing edge (1 to 0). If the pulse is inverse (1 to 0 to 1), the trigger event should be set to leading edge (1 to 0). The outputs of digital pulse filters are connected to event counters (EC). It counts the unfiltered pulses. If the MS switch is set to primary level, the output of primary event counter will change from 0 (FALSE) to 1 (TRUE) to indicate the valid trigger event after reaching the terminal count, which is user settable in the range of 1 to 32767. If the MS switch is set to secondary level, the output of primary event counter activates the secondary trigger level. The input selector, digital filter and event counter can be set for secondary level independently to define the valid trigger event.

The trigger circuits of the series M770 DSOs are equipped with Hold Off timer (TDL). It blocks the triggering event for time period  $T = 4 \cdot H \cdot T_s$  from the start of data acquisition, where  $T_s$  is the actual real time sampling period and  $H$  is the user selectable value from 0 to 32767. It is important to set the proper value  $H$  to ensure that the hardware of the oscilloscope acquires proper amount of data before trigger event. For example, if we want to display waveform for time period of  $T_z$  before the trigger it is necessary to set  $T \geq T_z$  to ensure that all of the data will be displayed.

The M770 series oscilloscopes have four triggering modes implemented:

**AUTO** – Data acquisition is triggered by a valid trigger event. However, when after certain time the trigger event does not occur, measurement starts.

**NORMAL** – Data acquisition is triggered by a valid trigger event.

**SINGLE** – Data acquisition starts after activation from the control panel and it is synchronized by the valid trigger event. Just one measuring cycle is executed.

**MANUAL** – One measuring cycle is executed immediately after activation from the control panel.

### 2.3.3. Data acquisition

The simplified block schematics of data acquisition is shown on figure 2.3.3.1.

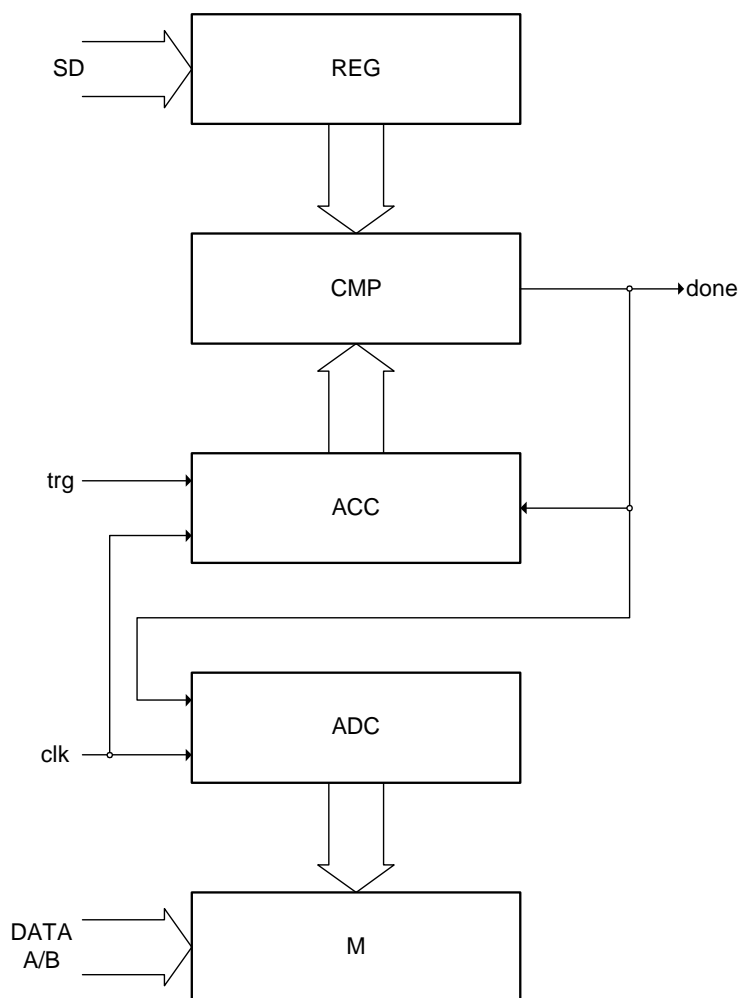

**Fig. 2.3.3.1. – Simplified block schematics of the data acquisition**

The data from AD converters are stored in the onboard memory M. This memory is addressed by address counter ADC, which starts to count immediately after start of measurement, regardless of trigger event. The occurrence of valid trigger event starts the after trigger data counter (ACC). Comparator CMP compares the state of ACC with the output of register (REG), which contains data amount acquired after trigger. When the output of ACC reaches the value written to REG, the comparator produces the signal (done), which stops both the ADC and ACC counters. The amount of data written after trigger to memory depends on the value of REG. The value written to REG controls the relation of the trigger event and the displayed data. Changing the value of REG it is possible to display data before, before and after or only after trigger.

## 2.4. Hardware description of the M595 oscilloscope

The M595 dual channel digital storage USB oscilloscope connects to the computer via USB. It is compatible with both USB 2.0 and USB 1.1. Measurement accuracy is achieved by the stability of the parts used together with the computing power of the computer. Calibration data are part of the HW, which makes it impossible to lose them (opposite to the calibration data located on the diskette). Therefore, it is possible to simply connect the hardware to any computer (via USB 1.1 or USB 2.0 interface). All you have to do is just installing the software.

The M595 oscilloscope allows user to measure waveforms using two independent channels with resolution of 8 bits and sensitivity from 10mV/div to 5V/div (80mVfs to 40Vfs) in 9 steps. One division of the oscilloscope screen contains 32 dots. Input impedance matches the oscilloscope standards therefore any regular oscilloscope probe (with minimum compensation range of 30pF) can be connected to the device. The software supports 1:1, 1:10, 1:100 and 1:1000 probes. AC or DC coupling and type of probe can be independently selected for each vertical channel. Any of the inputs can be grounded without disconnecting the probes from the measured system. Vertical track position can be controlled with accuracy of 1 pixel of the oscilloscope screen. Measurement can be triggered from the Channel A, Channel B and/or External trigger input. Trigger threshold can be set independently for each channel in the range of whole oscilloscope screen with resolution of one pixel. Threshold of the External trigger input is fixed to about 1.5V (TTL and CMOS compatible). The M595 oscilloscope has the dual level triggering system, which is closely described in chapter 2.1.2. Oscilloscope hardware offers data acquisition with maximum rate of 1GS/s for single channel and 500MS/s for dual channel operation. Therefore it is not possible to sample non-repetitive waveforms faster than every 1 or 2ns. However, thanks to random sampling method, it is possible to sample repetitive waveforms with period of 20ps, which corresponds with equivalent sampling rate of 50GS/s. For displaying waveforms acquired using the random sampling method, the ETC company has developed system called WCD (Waveform Conformity Detection), which speeds up display of changes of measured waveform.

The oscilloscope hardware can acquire data in one universal mode.

- **Acquiring data before and after trigger with settable trigger position** displays waveform before and/or after trigger. The position of the trigger is settable by the user. In this mode the hardware of the oscilloscope starts data acquisition immediately after the start of measurement. The trigger event terminates the data acquisition after collection the data amount set by the user. The trigger position can be set to any place between these margins. The "Hold Off" timer allows the user to prevent the occurrence of a trigger event after the start of data acquisition. This feature allows to acquire proper amount of data before the trigger.

Each measuring channel of the M595 has its own AD converter. No channel multiplexing is used for dual channel operation.

### 2.4.1. Digital Shielding (DSH)

Digital Shielding removes interference asynchronous with the measured signal, and it does not affect frequency characteristics of the measured waveform. The only negative effect of DSH is longer time period of waveform stabilization. It is,

however, very simple to turn the DSH off using the on-screen controls. The DSH efficiency level corresponds to DSH level factor that can be set to any value from 2 to 64. The higher the level you choose, the longer it takes to stabilize.

### 2.4.2. Trigger circuits



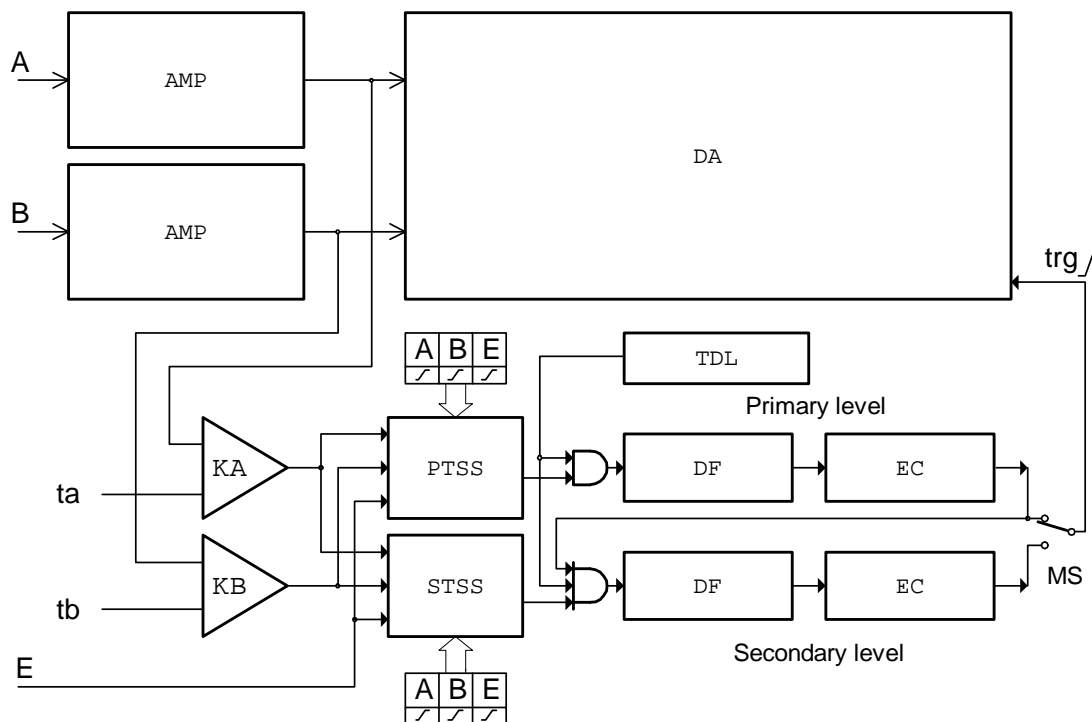















The block schematics of the dual level trigger circuits are shown on the figure 2.4.2.1.



**Fig. 2.4.2.1. – Block schematics of trigger circuits**

Data for trigger circuits come either from Channel A, Channel B or from external trigger input (E). The comparators KA and KB produce binary signals for Primary Trigger Source Selector (PTSS) and Secondary Trigger Source Selector (STSS) while the threshold of each comparator (ta, tb) can be set to any value in the vertical range. If the actual output voltage of the channel is higher than the actual threshold the output of comparator is set to 1 (TRUE). If it is lower than the threshold, the output will be 0 (FALSE). The Trigger Source Selectors for each triggering level are independent. It is possible to select the source of triggering signal for each level independently. In addition to source selection, the PTSS and STSS can invert any of the input signal. The trigger event is generated with respect to change of the selector (PTSS, STSS) output signal from 0 (FALSE) to 1 (TRUE). Constant level of the signal cannot start the measurement. In case that only one of the signals is selected, trigger event is generated corresponding to the polarity, which is symbolically presented by direction of change of the signal. (0 to 1 means no inversion). When there are several inputs selected, the selector makes a logical addition (OR) of all of the selected inputs. Before adding the signals together, ones are adjusted with respect to the polarity settings. Trigger event is generated only when the change of result of the logical addition occurred from 0 to 1 (FALSE to TRUE). Logical values of the signals in the input of logical adder (OR) from which the trigger event is generated are

created on the basis of following rules: value 0 (FALSE) is the value that selector input signal should have before valid trigger event. 1 (TRUE) is the value that this signal will have after the valid trigger event. For example, if triggering from Channel A is set to the trailing edge, then the output voltage of the channel is higher than the threshold voltage, consequent value on the adder input will be 0 (FALSE). Inverse situation will be taken as 1 (TRUE). Note that when using logical addition, all values must be 0 (FALSE) in order for result to be 0 (FALSE). It is relatively easy to find out which are the valid trigger events. Figure 2.4.2.2 shows several valid and invalid trigger events (all inputs are enabled).

				selected trigger event
	A	B	E	
			valid	
			invalid	
			invalid	
			valid	
			valid	

**Fig. 2.4.2.2. – Examples of trigger events (all inputs are enabled)**

The digital pulse filters (DF) are implemented in both primary and secondary trigger levels. If activated, they filter out pulses shorter than the value  $4 \cdot N \cdot T_s$ , where  $T_s$  is the actual real time sampling period and  $N$  is the value set by the user ( $1 \leq N \leq 32767$ ). If we want to use this option it is necessary to set the valid trigger event to the end of the pulse. For example, if the pulse we want to filter off is positive (0 to 1 to 0) the trigger event should be set to trailing edge (1 to 0). If the pulse is inverse (1 to 0 to 1), the trigger event should be set to leading edge (1 to 0). The outputs of digital pulse filters are connected to event counters (EC). It counts the unfiltered pulses. If the MS switch is set to primary level, the output of primary event counter will change from 0 (FALSE) to 1 (TRUE) to indicate the valid trigger event after reaching the terminal count, which is user settable in the range of 1 to 32767. If the MS switch is set to secondary level, the output of primary event counter activates the secondary trigger level. The input selector, digital filter and event counter can be set for secondary level independently to define the valid trigger event.

The trigger circuits of the series M570 DSOs are equipped with Hold Off timer (TDL). It blocks the triggering event for time period  $T = 4 \cdot H \cdot T_s$  from the start of data acquisition, where  $T_s$  is the actual real time sampling period and  $H$  is the user selectable value from 0 to 32767. It is important to set the proper value  $H$  to ensure that the hardware of the oscilloscope acquires proper amount of data before trigger event. For example, if we want to display waveform for time period of  $T_z$  before the trigger it is necessary to set  $T \geq T_z$  to ensure that all of the data will be displayed.

The M595 oscilloscope has four triggering modes implemented:

**AUTO** – Data acquisition is triggered by a valid trigger event. However, when after certain time the trigger event does not occur, measurement starts.

**NORMAL** – Data acquisition is triggered by a valid trigger event.

**SINGLE** – Data acquisition starts after activation from the control panel and it is synchronized by the valid trigger event. Just one measuring cycle is executed.

**MANUAL** – One measuring cycle is executed immediately after activation from the control panel.

### 2.4.3. Data acquisition

The simplified block schematics of data acquisition is shown on Figure 2.4.3.1.

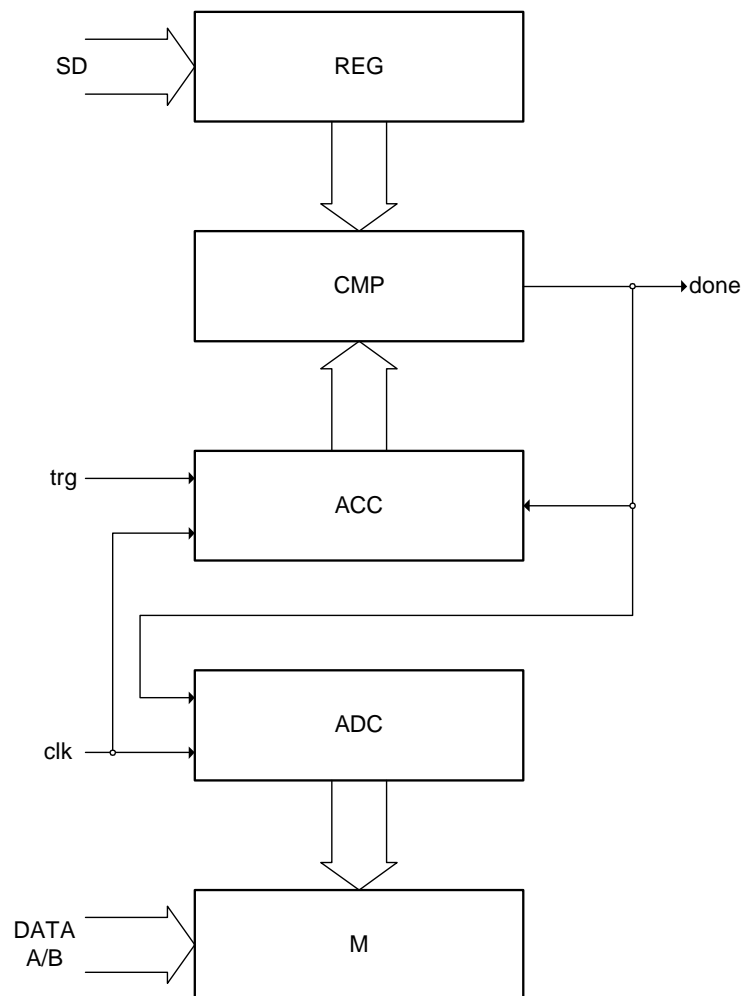

**Fig. 2.4.3.1. – Simplified block schematics of the data acquisition**

The data from AD converters are stored in the onboard memory M. This memory is addressed by address counter ADC, which starts to count immediately after start of measurement, regardless of trigger event. The occurrence of valid trigger event starts the after trigger data counter (ACC). Comparator CMP compares the state of ACC with the output of register (REG), which contains data amount acquired after trigger. When the output of ACC reaches the value written to REG, the comparator produces the signal (done), which stops both the ADC and ACC counters. The amount of data written after trigger to memory depends on the value of REG. The value written to REG controls the relation of the trigger event and the displayed data. Changing the

value of REG it is possible to display data before, before and after or only after trigger.



### 3. Basic information

#### 3.1. Front and rear panel layout

##### 3.1.1. Front panel layout

Channel A, channel B, external synchronization input / compensation generator output and LED are accessible on the front panel.



*Fig. 3.1.1.1. – Front panel of the M570 series oscilloscope*



*Fig. 3.1.1.2. – Front panel of the M520 series oscilloscope*



*Fig. 3.1.1.3. – Front panel of the M770 series oscilloscope*

If the LED color is:

- green, the device is configured and there is no communication with a computer in this moment
- orange, the device communicates with a computer
- red, device is powered, but not configured

##### 3.1.2. M770 series rear panel layout

Two connectors are available on the rear panel.

- USB connector for communication with computer (used for supplying device with power as well)
- banana jack (4mm) for optional ground connection. This connector is connected to the ground (chassis) of the host computer and should be connected to the environment ground when the higher voltage than 50 V is connected to the instrument's measuring ground (shielding of the BNC connectors on the front panel).



*Fig. 3.1.2.1. – M770 series rear panel layout*

### 3.1.3. M595 oscilloscope rear panel layout

Two connectors are available on the rear panel.

- USB connector for communication with computer (used also for supplying a interface circuitry)

- Power connector for connection the auxiliary power source, which is usually the power adapter supplied in the basic package. The auxiliary power source should supply the voltage between 10 to 18VDC / 7W min. and connects to device by 2.1/5.5mm central + DC connector.



*Fig. 3.1.3.1. – M595 rear panel layout*

## 3.2. Basic terms

This Chapter explains the basic terms used throughout the text.

**Click** – Position the mouse cursor over the chosen object. Then press and release the left mouse button.

**Double-Click** – Two successive clicks.

**Drag** – Position the mouse cursor over the object you want to move. Then press the left mouse button and hold it down. The chosen object moves with the mouse cursor. After releasing the mouse button the object moves to the new location.

**Enter the value into the edit box** – Click the edit box. Use the keyboard to enter the desired value and confirm pressing “Enter”.

**Insert the value into the edit box** – Click the edit box. Use the keyboard to enter the desired value.

**Set the value using the scroll bar** – It is possible to change a value by simply dragging the scroll bar slider. Clicking the arrows of the scroll bar increases or decreases the value by minimal steps. Clicking in between the slider and the arrows changes the value by larger steps.

**Select the value from the combo box** – Open the list of all possible values of the edit box by clicking it. Then set the desired value by clicking it.

## 4. Main window

The window, which allows you to select the view mode, is displayed during the first application start.

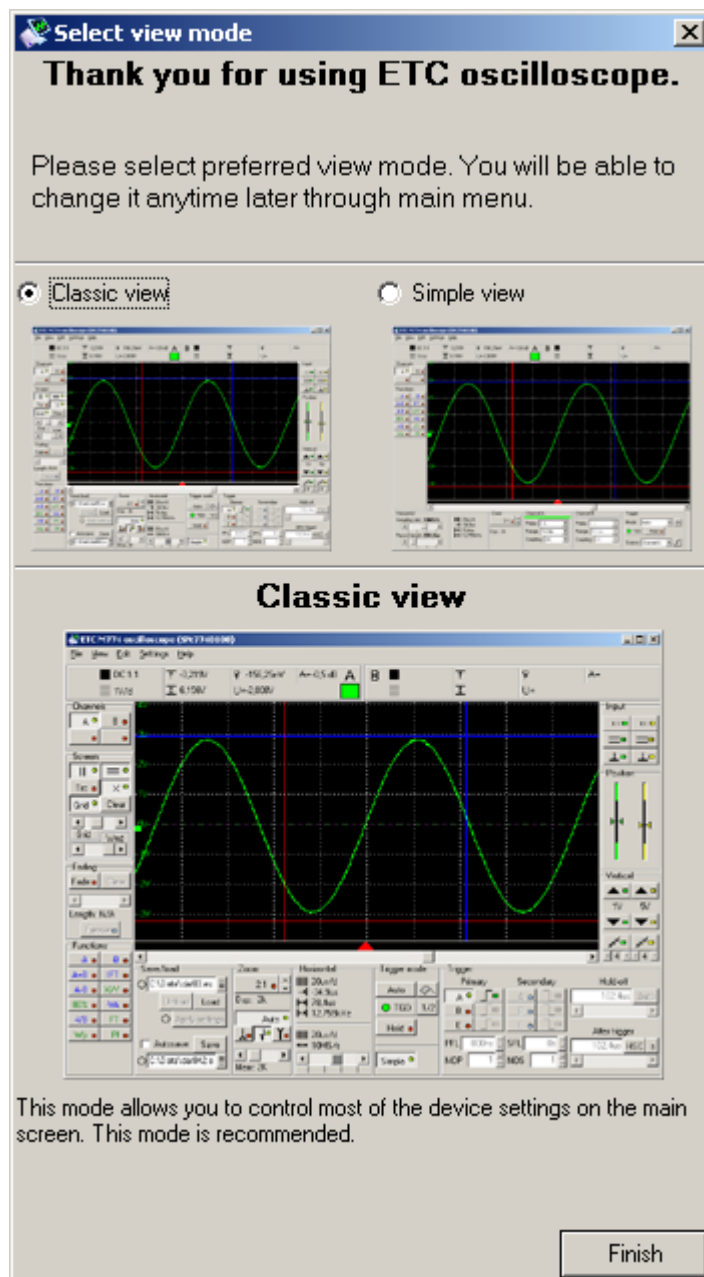

**Fig. 4.1. – View mode selection**

Two view modes are available: classic view and simple view.

The classic view allows you to control most of the oscilloscope parameters in the main window. This view enables access to all oscilloscope settings.

The simple view allows you to control the most important parameters in the main window. This view sets advanced parameters (such as secondary level of the trigger system) automatically.

### 4.1. Main window in classic view

The main window opens after the application starts, if the classic view is selected. The controls in this window allow you to use most of the oscilloscope functions.

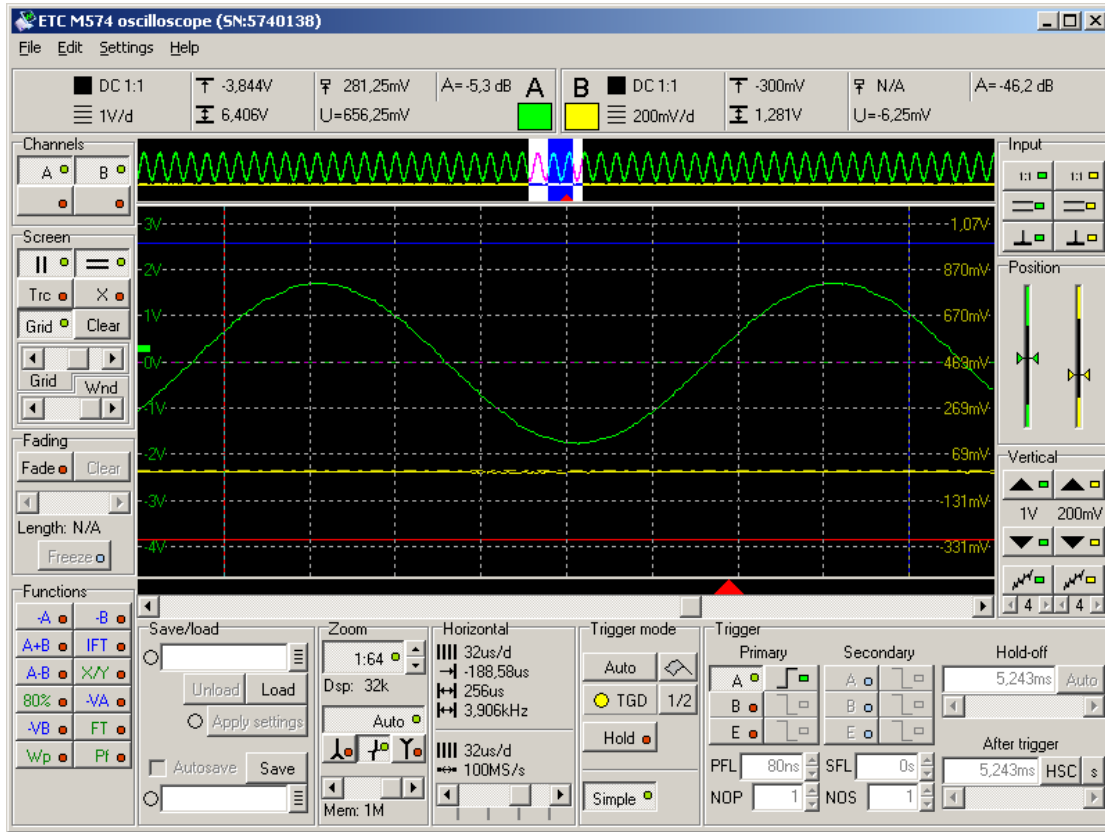

*Fig. 4.1.1. – Main window in classic view*

All controls connected to one of the channels have channel color.

---

**TIP: The channel color can be changed in main menu.**

---

#### 4.1.1. Oscilloscope screen

The oscilloscope screen is located in the middle of the main window.

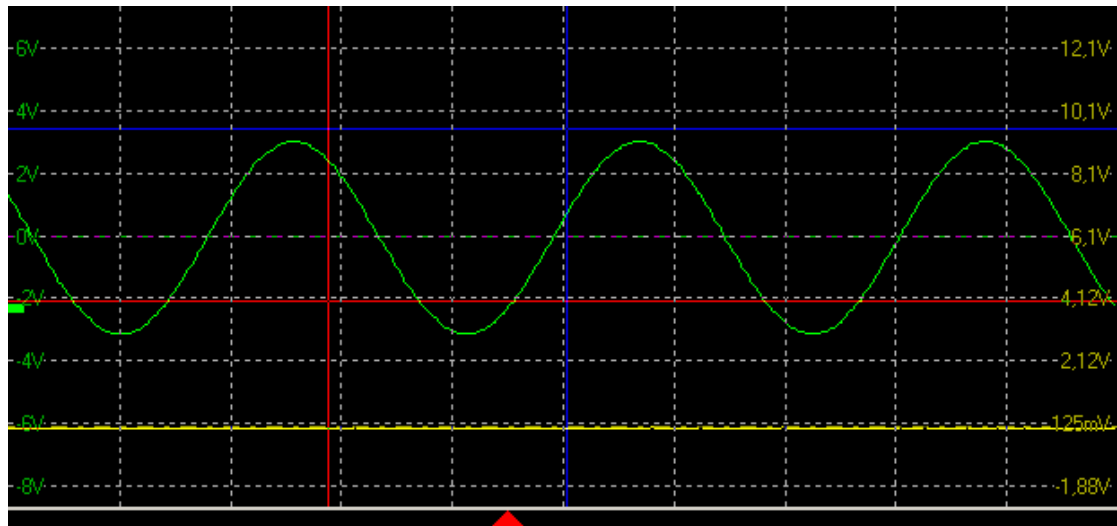

*Fig. 4.1.1.1. – Oscilloscope screen*

The oscilloscope screen is divided into 10 horizontal and 8 vertical divisions.

---

**TIP: You can activate the „Dynamic grid position (ground line)“ mode in the options. This mode adjusts the grid position to keep the ground of channel A (or channel B, if channel A is turned off) on one of the horizontal grid lines.**

---

Where the „Display legend“ is turned on in the options, the voltage of each horizontal grid line is displayed (channel A on the left, channel B on the right).

The trigger event is marked with the red triangle located in the bottom of the screen. If the trigger event occurred before the displayed waveform, the arrow pointing left is drawn. If the trigger event occurred after the displayed waveform, the arrow pointing right is drawn.

---

**WARNING: The trigger mark position can slightly differ (especially when using fast timebase) from the real position of the trigger event.**

---



---

**TIP: Drag the trigger mark (red arrow) to set the after trigger amount. This feature can be turned off in main menu.**

---

Where the „Display ground level“ is turned on in the options, the horizontal dotted line of the appropriate channel color is displayed. If the „Allow vertical shift change by dragging ground position“ is turned on in the options, drag this line to set the vertical shift of the appropriate channel.

Two vertical and two horizontal cursors can be activated. Vertical cursors have red (cursor 1) and blue (cursor 2) color by default. Horizontal cursors have red (cursor 1) and blue (cursor 2) color by default as well.

---

**TIP: The cursors color can be changed in main menu.**

---

You can move cursor by dragging it.

The waveform is drawn using the channel color. The default channel colors are following: Channel A green, channel B yellow, virtual channel (the one used for display of function result) C is light blue and channel D is orange.

---

**TIP: The channel colors can be changed in main menu.**

---

The threshold voltage mark is located in the left. You can change threshold voltage by dragging it.

---

**TIP: If the used memory size is larger than 64k, the quickview is displayed above the oscilloscope screen. Use the quickview to select the 64k long part of the memory, that can be displayed in the oscilloscope screen.**

---

Click „Fade“ button to activate fading display. Please see chapter 4.16. for more information.

### 4.1.2. Quickview

If the used memory size is larger than 64k, the quickview is displayed above the oscilloscope screen.

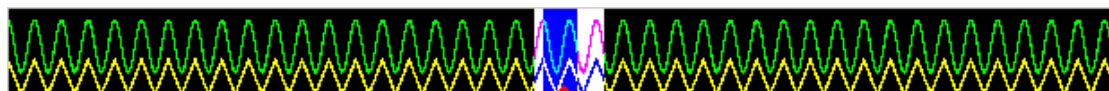

*Fig. 4.1.2.1. – Quickview*

The white rectangle indicates the part, which can be displayed in the oscilloscope screen. Drag this rectangle to change its position.

The blue rectangle indicates the part, which is displayed in the oscilloscope screen. Drag this rectangle to change its position.

The triangle in the bottom of the quickview indicates the trigger position.

---

**TIP: You can turn the quickview on/off in main menu. If the quickview is turned off, you can display more than 64k samples in the oscilloscope screen.**

---

---

**WARNING: The quickview is available only for the oscilloscope with more than 64k memory size.**

---

### 4.1.3. Cursors and grid controls

The cursors and grid controls are located in the left part of the main window.



*Fig. 4.1.3.1. – The cursors and grid controls*



- activates/deactivates vertical cursors.



- activates/deactivates horizontal cursors.

„Grid“ - activates/deactivates grid.

„Trc“ - activates/deactivates the Trace mode, where the cursors behave as follows:

- the cursor 2 behaviour is not affected
- while dragging cursor 1, the cursor 2 moves to maintain the distance between cursors

„X“ - activates/deactivates mode, where the drag of cursors intersection moves both cursors

„Clear“ - clears all acquired waveforms on the screen

The top scrollbar (Grid) adjusts grid brightness. The bottom scrollbar (Wnd) adjusts window transparency.

---

**TIP: The grid color can be changed in main menu.**

---



---

**WARNING: The window transparency consumes system resources when turned on. Drag scrollbar to the right to turn the window transparency off.**

---



---

**WARNING: The window transparency is supported by the Windows 2000 and Windows XP. In case, the software runs under different operating system, the scrollbar is disabled.**

---

#### 4.1.4. Channel display controls

The channel controls are located in the left of the main window.



*Fig. 4.1.4.1. – Channel display controls*

„A“ - activates/deactivates channel A waveform

„B“ - activates/deactivates channel B waveform

The special function can be activated by click on the appropriate button (located in special functions box) followed by click on one of the buttons located in the bottom of the channel controls. Function results are displayed with the color of the selected virtual channel (left button is channel C, right one is channel D).

### 4.1.5. Save/load controls

The save/load controls are located in the bottom of the main window.

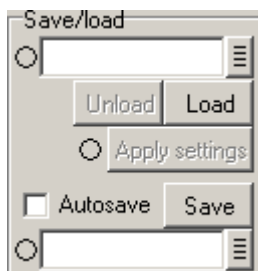

*Fig. 4.1.5.1. – Save/load controls*

The load controls are located in the panel top.

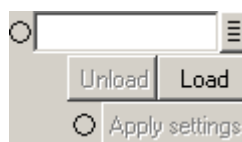

*Fig. 4.1.5.2. – Load controls*

The name of source file has to be inserted into the upper edit box. Click  to browse for the file.

Click “Load” button to load and display data. The indicator by the edit box turns green on successful load.

---

**TIP: If the filename ends with the number, this number can be automatically incremented on the successful load (this feature can be turned on/off through main menu).**

---

Click “Unload” button to stop displaying the loaded data.

Click “Apply settings” to set the settings loaded from the data file.

---

**TIP: The settings can be applied automatically (this feature can be turned on/off through main menu).**

---

Indicator by the „Apply settings“ button changes color depending on the actual settings this way:

Green – the actual settings and settings from the data file are same

Yellow – the actual settings differs from the settings from the data file in some parameters, but the range and timebase settings are same

Red – the actual settings differs from the settings from the data file in range or timebase settings

The save controls are located in the panel bottom.

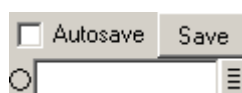



**Fig. 4.1.5.3. – Save controls**

The name of target file has to be inserted into the upper edit box. Click  to browse for the file.

Click “Save” button to save data. The indicator by the edit box turns green on successful save.

---

**TIP: If the filename ends with the number, this number can be automatically incremented on the successful save (this feature can be turned on/off through main menu).**

---

If the autosave is enabled in the options (see chapter 4.14.1.), it is possible to activate this mode by checking the „Autosave“ checkbox.

The acquired data are automatically saved in this mode after every acquisition and the filename is automatically incremented after save (if possible).

#### 4.1.6. Zoom controls

The zoom controls are located in the bottom of the main window.

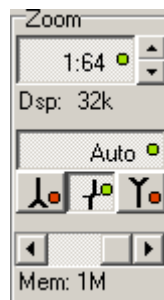
**Fig. 4.1.6.1. – Zoom controls**

Click top button to activate/deactivate zoom.

---

**TIP: While scrolling the scrollbar (the one under the main screen) with zoom deactivated, two violet lines are drawn on the screen. These lines determine the part of waveform displayed with activated zoom.**

---

 ,  – change zoom factor

If there are more than 500 samples displayed on the screen, one displayed sample has to be calculated out of more than one measured sample. The samples are then displayed as follows in this case:

If the  button is activated, the displayed sample is calculated as average of the measured samples.

If the  button is activated, the displayed sample is calculated as a maximum of measured samples.

If the  button is activated, the displayed sample is calculated as a minimum of measured samples.

If both the  button and  button are activated, the line connecting measured sample with maximum and minimum value is displayed.

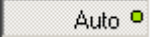
The software can automatically select suitable display mode by analyzing input waveform. Click  button to activate/deactivate this.

---

**TIP: The software selects correct display mode with high probability. We recommend to use „Auto“ mode for most measurements.**

---

Use the scrollbar in the bottom of the panel to change the used memory size.

#### 4.1.7. Timebase controls



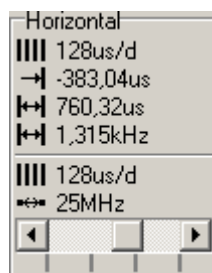

The timebase controls are located in the bottom of the main window.





*Fig. 4.1.7.1. – Timebase controls*

You can change timebase using scrollbar located in the bottom.

Following information are available above the divider:

-  - time of one screen division (used to acquire currently displayed data)
-  - time between trigger event and vertical cursor 1
-  - time between vertical cursors
-  - frequency between vertical cursors

Following information are available below the divider:

-  - time of one screen division (current settings)
-  - sampling rate (current settings)

---

**WARNING: If the information about the time between trigger event and vertical cursor 1 has to be accurate (error smaller than 10ns), it is necessary to make following correction: measure time between trigger event mark and real trigger event and use this value to correct the information.**

---

If the sampling mode is activated, the  is displayed with two rectangles reflecting the amount of samples acquired (left rectangle represents channel A, right one represents channel B):

red – less than 50% samples are acquired

yellow – more than 50% but less than 100% samples are acquired

green – 100% samples are acquired

#### 4.1.8. Trigger mode controls

The trigger mode controls are located in the bottom of the main window.





*Fig. 4.1.8.1. – Trigger mode controls*

Click button on the top left corner to switch between following trigger modes:

„Normal“ – It produces sweep only when the trigger signal meets the threshold level and slope criteria. If the “Enable flag in normal trigger mode (starts acquisition)” is enabled in the options, clicking on the  button starts data acquisition with no regard to the trigger.

„Auto“ – Measurement if repeatedly triggered. If the trigger event does not occur before timeout, the sweep free-runs without the trigger signal; otherwise it is triggered by trigger.

„Single“ – Single measurement. Starts by clicking on the  button. Sweep is produced only when trigger signal meets the threshold level and slope criteria.

„Manual“ – Single measurement. Starts by clicking on the  button. Sweep is produced regardless the trigger signal.

The „TGD“ indicator reflects the measurement state by changing its color:

red – the measurement has started, but the trigger event has not occurred yet

yellow – the measurement has started, trigger conditions met, but the data acquisition hasn't finished yet

green – the measurement has ended, the data are displayed on the oscilloscope screen

“1/2” – sets the trigger threshold to the middle between maximum and minimum value of the waveform.

“Hold” – pauses the measurement

“Simple” – switches trigger controls to/from simple mode. The secondary triggering level is deactivated, the trigger counter on primary level is set to one and a digital filter on the primary level is activated and set to minimum value in simple mode.

In case the “Separate hold of channel A and B” option is enabled, the controls, which allow separate “hold” are displayed.

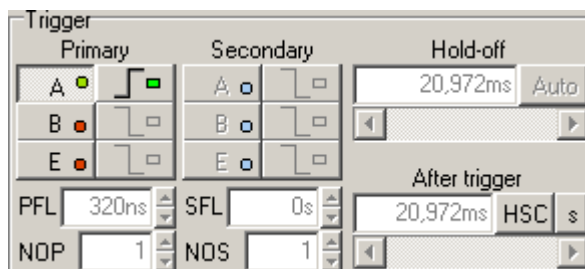

**Fig. 4.1.8.2. – Trigger mode controls with separate hold controls**

Click “A” button to pause measurement on channel A, click “B” button to pause measurement on channel B.

### 4.1.9. Trigger controls

The trigger controls are located in the bottom of the main window.



**Fig. 4.1.9.1. – Trigger controls**

The trigger source controls are located in the left.



**Fig. 4.1.9.2. – Trigger source controls**

Left buttons control primary level, the right ones control secondary level.

“A” – activates/deactivates channel A as triggering source

“B” – activates/deactivates channel B as triggering source

“E” – activates/deactivates triggering from external triggering input (E)

 - switches between sensitivity on leading/trailing edge

You can enter required trigger event occurrences count into NOP (primary level) or NOS (secondary level) edit box. The count can be any value from 1 to 65535.

You can enter minimum length of trigger event considered as valid into PFL (primary level) or SFL (secondary level) edit box.

---

**TIP: You can use units in the PFL/SFL edit box (for example 45u is 45 microseconds). Valid units are: n – nano, u – micro, m – milli).**

---

The after trigger amount controls are located in the bottom right corner.

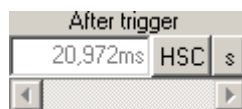

**Fig. 4.1.9.3. – After trigger amount controls**

The button in the right switches between following after trigger modes:

“HSC“ – Half of the memory is acquired after, other half before trigger.

“FSC“ – Whole memory is acquired after trigger. This, in fact, is the classic after trigger mode.

“MIN“ – The amount of data acquired after trigger is set to minimal possible value (pure before trigger mode).

“SET“ – The time acquired after trigger event can be set by entering value into the edit box or using scrollbar.

---

**TIP: You can use units in the edit box (for example 45u is 45 microseconds). Valid units are: n – nano, u – micro, m – milli).**

---



---

**TIP: Drag the trigger mark (red arrow) to set the after trigger amount. This feature can be turned off in main menu.**

---

Click the „s“ or „%“ button to change the information, which will be displayed in after trigger edit box:

In case the „s“ is selected:

- the after trigger amount is displayed in seconds

- when the oscilloscope settings changes, the software changes the amount of samples acquired after trigger to keep the selected time (for example increasing sampling rate twice increases amount of samples after trigger twice)

In case the „%“ is selected:

- the after trigger amount is displayed in percents of memory size

- when the oscilloscope settings changes, the software changes the amount of samples acquired after trigger to keep the selected part of the memory after trigger (for example increasing memory size twice increases amount of samples after trigger twice)

The hold-off controls are located in the top right corner.

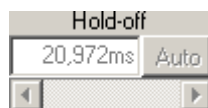

**Fig. 4.1.9.4. – Hold-off controls**

The button in the right switches between following hold-off modes:

“AUTO” – The hold-off time is set to guarantee acquisition of the whole memory.

“SET” – The hold-off time can be set by entering value into edit box or using scrollbar.

---

**TIP: You can use units in the edit box (for example 45u is 45 microseconds). Valid units are: n – nano, u – micro, m – milli).**

---

#### 4.1.10. Vertical range controls

The vertical range controls are located in the right of the main window.



*Fig. 4.1.10.1. – Range controls*

Channel A controls are located in the left, channel B controls are located in the right.



- changes the range to less sensitive



Range with no respect to probe attenuation is displayed below this button.



- changes the range to more sensitive



- activates/deactivates digital shielding

Click  or  to decrease or increase digital shielding level.

#### 4.1.11. Vertical shifts controls

The vertical shift controls are located in the right of the main window.

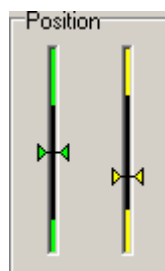

*Fig. 4.1.11.1. – Vertical shift controls*

Channel A controls are located in the left, channel B controls are located in the right.

The main screen position is highlighted by the rectangle of main screen color (black by default) – if this is switched on in the options.

Click between above or below the slider to shift waveform by smallest possible value.

The vertical shift can be set by dragging the slider as well.

---

**TIP: Keeping the mouse button pressed above or below slider results in shift by 20 smallest possible values per second.**

---

It is possible to change the vertical shift by dragging the waveform on the main screen.

---

**TIP: Changing the vertical shift by dragging the waveform can be turned on/off in main menu.**

---

#### 4.1.12. Signal source controls

The signal source controls are located in the right of the main window.

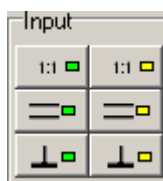

*Fig. 4.1.12.1. – Signal source controls*

Channel A controls are located in the left, channel B controls are located in the right.

“1:1”, “1:10”, “1:100” or “1:1000” – probe attenuation ratio

---

**WARNING: Selection of improper probe attenuation ration may result in wrong information about voltages.**

---

Click or to select coupling. Click to ground input.

#### 4.1.13. Channel information

The channel information are displayed in the top of the main window.

Channel A information are located in the left, channel B information are located in the right.

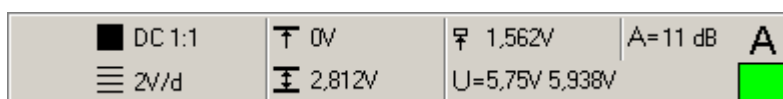

*Fig. 4.1.13.1. – Channel information*

Following information are displayed:

- information about coupling and probe attenuation ratio
- range

**T** - voltage between horizontal cursor 1 and 0V (this information is not displayed when coupling is set to AC)

**I** - voltage between horizontal cursor 1 and 2

---

**WARNING: If the improper probe attenuation is set, the information will be inaccurate.**

---

„U(t)“ – minimum and maximum (in case more than one sample is displayed on one point of the screen) voltage between 0V and the intersection of vertical cursor 1 and waveform

**F** - trigger threshold voltage

“A” – ratio of the peak-peak voltage of the waveform on the screen and the voltage between horizontal cursors in decibels

#### 4.1.14. Special functions controls

The special functions controls are located in the lower left corner of the main window.



*Fig. 4.1.14.1. – Special functions controls*

Two function types exist:

1. Transformation functions, which display result on the main screen using virtual channel. These have blue color.

2. Other functions, which doesn't display result on the main screen. These have green color.

Click one of the transformation function button to half-activate it. After click on the desired virtual channel, the function is fully activated and the results are displayed with the color of the selected virtual channel.

Click one of the other function button to activate it.

You can find special functions description in chapter 6.

#### 4.1.15. Fading controls

It is possible to display data on the screen with persistence (fading mode). When in this mode, the old waveform isn't removed from the screen when a new one is being drawn. Old waveforms will fade for the selected time. Waveforms older than the selected time are removed from the screen.

The fading controls are located in the left part of the main window.





**Fig. 4.1.15.1. – Fading controls**

Click „Fade“ button to activate fading mode.

Click „Clear“ button to clear old waveforms.

The persistence length can be selected using the scrollbar located in the middle of the controls (persistence length can be set to 0.5s, 1s, 2s, 5s, 10s, 20s, 50s, 100s and 3600s).

Click „Freeze“ button to suspend fading of the old waveforms and updating of the new one. When the fading is frozen, it is not possible to change any parameters, which affects the waveform on the screen (such as seeking in the device memory, resizing window ...).

---

**WARNING: The fading mode is much more processor and graphic card intensive than standard display mode. Therefore, the update rate of the waveform can be slower.**

---

## 4.2. Main window in simple view

The main window opens after the application starts, if the simple view is selected. The controls in this window allow you to use the most important oscilloscope functions. Please use classic view for more advanced oscilloscope settings.

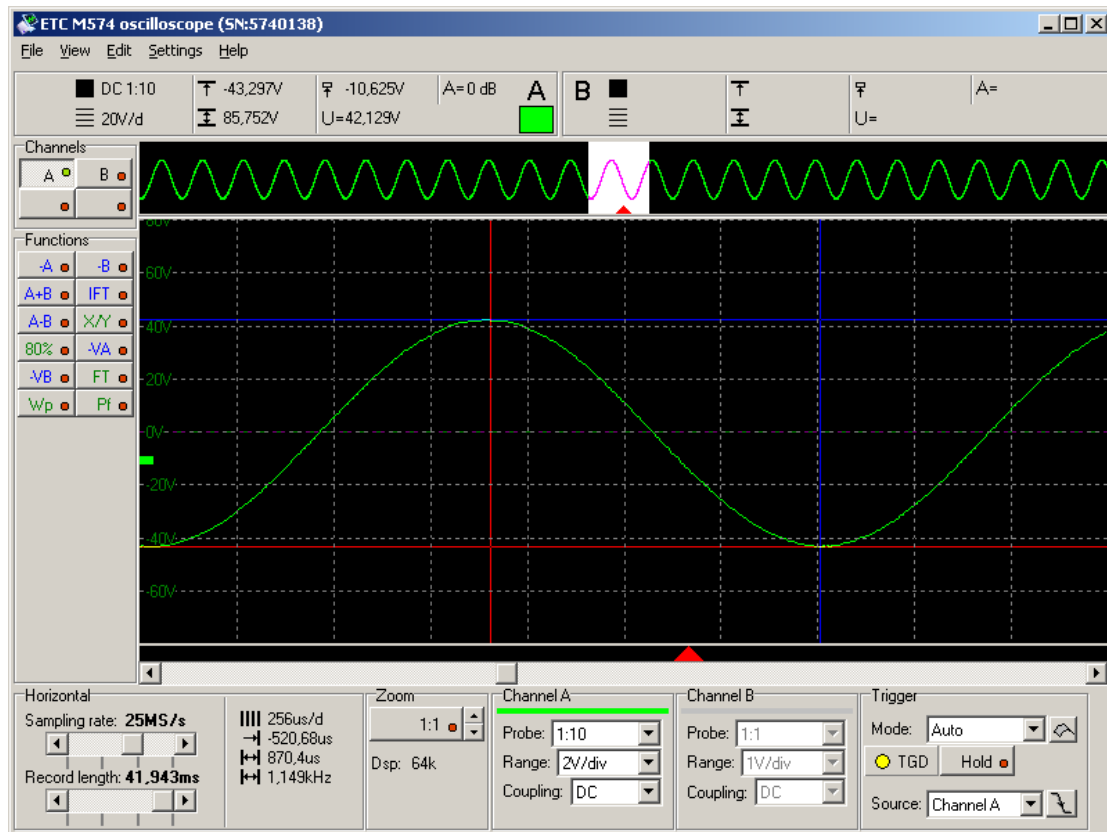

*Fig. 4.2.1. - Main window in simple view*

All controls connected to one of the channels have channel color.

**TIP: The channel color can be changed in main menu.**

### 4.2.1. Oscilloscope screen

The oscilloscope screen is located in the middle of the main window.

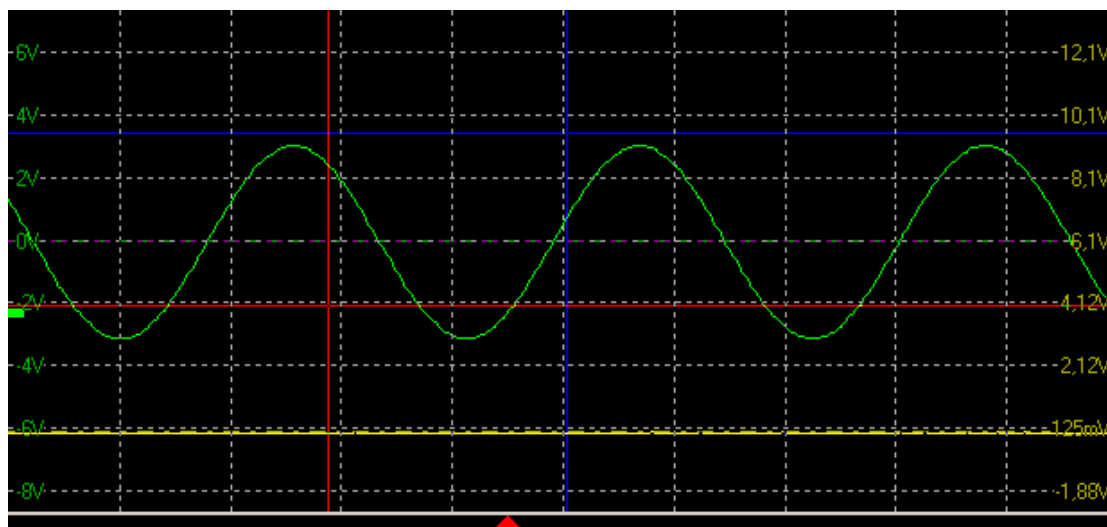

*Fig. 4.2.1.1. – Oscilloscope screen*

The oscilloscope screen is divided into 10 horizontal and 8 vertical divisions.

Drag the grid horizontal lines to set vertical shift on the channel A (or channel B, if the channel A is turned off).

The grid position is adjusted to keep the ground of channel A (or channel B, if channel A is turned off) on one of the horizontal grid lines.

The voltage of each horizontal grid line is displayed (channel A on the left, channel B on the right).

The trigger event is marked with the red triangle located in the bottom of the screen. If the trigger event occurred before the displayed waveform, the arrow pointing left is drawn. If the trigger event occurred after the displayed waveform, the arrow pointing right is drawn.

---

**WARNING: The trigger mark position can slightly differ (especially when using fast timebase) from the real position of the trigger event.**

---

The horizontal dotted line of the appropriate channel color indicates the ground position of the appropriate channel. Drag this line to set the vertical shift of the appropriate channel. If the ground position is out of the screen, the arrow with ground symbol is displayed on the top or bottom of the main window. Drag this arrow to get ground position back to the screen.

Two vertical and two horizontal cursors can be activated. Vertical cursors have red (cursor 1) and blue (cursor 2) color by default. Horizontal cursors have red (cursor 1) and blue (cursor 2) color by default as well.

---

**TIP: The cursors color can be changed in main menu.**

---

You can move cursor by dragging it.

The waveform is drawn using the channel color. The default channel colors are following: Channel A green, channel B yellow, virtual channel (the one used for display of function result) C is light blue and channel D is orange.

---

**TIP: The channel colors can be changed in main menu.**

---

The threshold voltage mark is located in the left. You can change threshold voltage by dragging it.

---

**TIP: If the used memory size is larger than 64k, the quickview is displayed above the oscilloscope screen. Use the quickview to select the 64k long part of the memory, that can be displayed in the oscilloscope screen.**

---

#### 4.2.2. Quickview

If the used memory size is larger than 64k, the quickview is displayed above the oscilloscope screen.

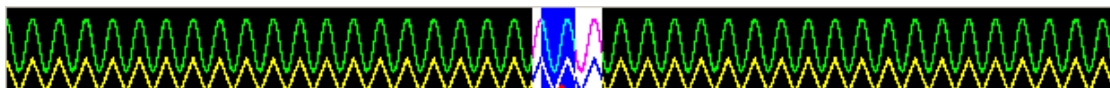

**Fig. 4.2.2.1. – Quickview**

The white rectangle indicates the part, which can be displayed in the oscilloscope screen. Drag this rectangle to change its position.

The blue rectangle indicates the part, which is displayed in the oscilloscope screen. Drag this rectangle to change its position.

The triangle in the bottom of the quickview indicates the trigger position.

---

**TIP: You can turn the quickview on/off in main menu. If the quickview is turned off, you can display more than 64k samples in the oscilloscope screen.**

---



---

**WARNING: The quickview is available only for the oscilloscope with more than 64k memory size.**

---

### 4.2.3. Channel display controls

The channel controls are located in the left of the main window.

**Fig. 4.2.3.1. – Channel display controls**

„A“ – activates/deactivates channel A waveform

„B“ – activates/deactivates channel B waveform

The special function can be activated by click on the appropriate button (located in special functions box) followed by click on one of the buttons located in the bottom of the channel controls. Function results are displayed with the color of the selected virtual channel (left button is channel C, right one is channel D).

### 4.2.4. Special functions controls

The special functions controls are located in the lower left corner of the main window.

**Fig. 4.2.4.1. – Special functions controls**

Two function types exist:

1. Transformation functions, which display result on the main screen using virtual channel. These have blue color.

2. Other functions, which doesn't display result on the main screen. These have green color.

Click one of the transformation function button to half-activate it. After click on the desired virtual channel, the function is fully activated and the results are displayed with the color of the selected virtual channel.

Click one of the other function button to activate it.

You can find special functions description in chapter 6.

#### 4.2.5. Zoom controls

The zoom controls are located in the bottom of the main window.

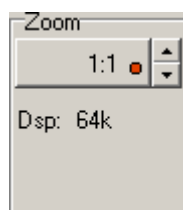

*Fig. 4.2.5.1. – Zoom controls*

Click top button to activate/deactivate zoom.

---

**TIP: While scrolling the scrollbar (the one under the main screen) with zoom deactivated, two violet lines are drawn on the screen. These lines determine the part of waveform displayed with activated zoom.**

---

▲, ▼ – change zoom factor

If there are more than 500 samples displayed on the screen, one displayed sample has to be calculated out of more than one measured sample. The way this processing occurs is selected automatically by software.

#### 4.2.6. Timebase controls

The timebase controls are located in the bottom of the main window.

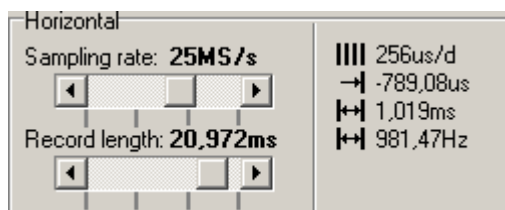

*Fig. 4.2.6.1. – Timebase controls*

Drag top scrollbar to change sampling rate.

Drag bottom scrollbar to change record length (used memory size of the device).

You can change timebase using scrollbar located in the bottom.

Following information are available right of the divider:

▮▮▮ - time of one screen division (used to acquire currently displayed data)

→ - time between trigger event and vertical cursor 1

↔ - time between vertical cursors

↔ - frequency between vertical cursors

---

**WARNING: If the information about the time between trigger event and vertical cursor 1 has to be accurate (error smaller than 10ns), it is necessary to make following correction: measure time between trigger event mark and real trigger event and use this value to correct the information.**

---

If the sampling mode is activated, the ▮▮▮ is displayed with two rectangles reflecting the amount of samples acquired (left rectangle represents channel A, right one represents channel B):

red – less than 50% samples are acquired

yellow – more than 50% but less than 100% samples are acquired

green – 100% samples are acquired

#### 4.2.7. Channel controls

The channel controls are located in the bottom of the main window.

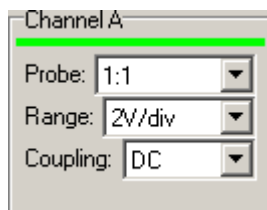

*Fig. 4.2.7.1. – Channel controls*

Click „Probe“ combobox to select the probe attenuation on the appropriate channel.

Click „Range“ combobox to select range on the appropriate channel.

Click „Coupling“ combobox to select coupling on the appropriate channel.

#### 4.2.8. Trigger controls

The trigger controls are located in the bottom of the main window.

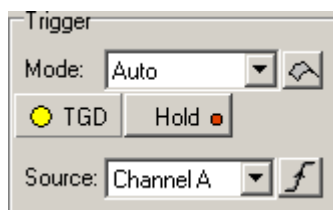

*Fig. 4.2.8.1. – Trigger controls*

Click „Mode“ combobox to select trigger mode. Following four trigger modes are available:

„Normal“ – It produces sweep only when the trigger signal meets the threshold level and slope criteria. If the “Enable flag in normal trigger mode (starts acquisition)”

is enabled in the options, clicking on the  button starts data acquisition with no regard to the trigger.

„Auto“ – Measurement if repeatedly triggered. If the trigger event does not occur before timeout, the sweep free-runs without the trigger signal; otherwise it is triggered by trigger.



„Single“ – Single measurement. Starts by clicking on the  button. Sweep is produced only when trigger signal meets the threshold level and slope criteria.

„Manual“ – Single measurement. Starts by clicking on the  button. Sweep is produced regardless the trigger signal.

The „TGD“ indicator reflects the measurement state by changing its color:  
 red – the measurement has started, but the trigger event has not occurred yet  
 yellow – the measurement has started, trigger conditions met, but the data acquisition hasn't finished yet  
 green – the measurement has ended, the data are displayed on the oscilloscope screen

Click „Hold“ button to pause measurement.

Click „Source“ combobox to select trigger source.

Click  or  to select trigger sensitivity on the leading or trailing edge.

#### 4.2.9. Channel information

The channel information are displayed in the top of the main window.

Channel A information are located in the left, channel B information are located in the right.

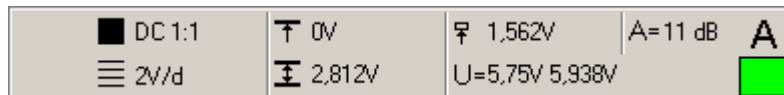

*Fig. 4.1.13.1. – Channel information*

Following information are displayed:

- - information about coupling and probe attenuation ratio
- ≡ - range
- ↑ - voltage between horizontal cursor 1 and 0V (this information is not displayed when coupling is set to AC)
- ⌘ - voltage between horizontal cursor 1 and 2

---

**WARNING: If the improper probe attenuation is set, the information will be inaccurate.**

---

„U(t)“ – minimum and maximum (in case more than one sample is displayed on one point of the screen) voltage between 0V and the intersection of vertical cursor 1 and waveform

⌘ - trigger threshold voltage

“A” – ratio of the peak-peak voltage of the waveform on the screen and the voltage between horizontal cursors in decibels

### 4.3. Main menu

The main menu is located in the top of the main window. Following menu items are available:

*File / Print* – Opens print manager.

*File / Exit* – Closes application.

*View / Simple mode* – Activates simple mode of the main window.

*View / Classic mode* – Activates classic mode of the main window.

*Edit / Export as ASCII / Manage exports* – Opens the window, where the export definitions can be configured. Click item in the *File / Export as ASCII* to export data using specified definition.

*Edit / Export as image / Manage exports* – Opens the window, where the export definitions can be configured. Click item in the *File / Export as image* to export data using specified definition.

*Settings / Save settings* – Saves current settings into selected file

*Settings / Load settings* – Loads settings from selected file

*Settings / Reset to factory defaults* – Restores factory default

*Settings / Process licence file* – Loads and processes specified licence file

*Settings / External trigger output / Compensation generator* – Activates/deactivates compensation generator.

*Settings / External trigger output / Synchro pulse* – Activates/deactivates synchronization pulse (if supported by the device)

*Settings / WCD sensitivity / Very high* – Sets very high WCD sensitivity.

*Settings / WCD sensitivity / High* – Sets high WCD sensitivity

*Settings / WCD sensitivity / Medium* – Sets medium WCD sensitivity

*Settings / WCD sensitivity / Low* – Sets low WCD sensitivity

*Settings / WCD sensitivity / Off* – Turns the WCD off

*Settings / Digital shielding level* – Opens window, where you can select digital shielding level.

*Settings / Options* – Opens the window, where the software options can be changed

*Help / Help* – Displays the Help index

*Help / View readme* – Opens the readme.txt file, which contains information about implemented changes in the application

*Help / About* – Displays information about product.

#### 4.3.1. Options

Click the item in the main menu to open options window.



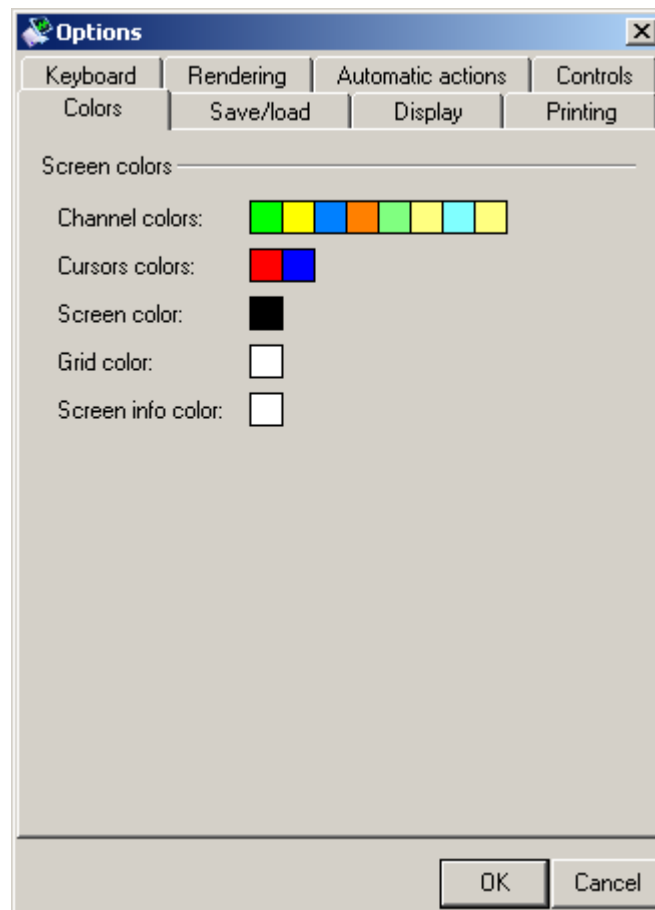

**Fig. 4.3.1.1. – Options window**

Following options are available:

*Colors / Screen colors / Channel colors* – click color of the channel to change it

*Colors / Screen colors / Cursors colors* – click color of the cursor to change it

*Colors / Screen colors / Screen color* – click color to change the screen background

*Colors / Screen colors / Grid color* – click color to change the grid color

*Colors / Screen colors / Screen info color* – click color to change the color of the text on the main screen

*Save/load / Save behaviour / Automatically increment filename* – if the filename of the target file ends with number, that number will be automatically incremented on successful save

*Save/load / Save behaviour / Enable autosave option* – Enables/disables checkbox on the main screen, which turns autosave on/off. Check checkbox on the main window to activate the mode, in which the data are saved to disk automatically after they are acquired.

*Save/load / Load behaviour / Automatically increment filename* – if the filename of the source file ends with number, that number will be automatically incremented on successful load

*Save/load / Load behaviour / Automatically apply settings* – settings from data file will be automatically applied on successful load

*Save/load / X and Y offset / Allow X offset change by dragging waveform* – the X offset of the loaded waveform can be changed by dragging the waveform on the oscilloscope screen

*Save/load / X and Y offset / Allow Y offset change by dragging waveform* – the Y offset of the loaded waveform can be changed by dragging the waveform on the oscilloscope screen

*Display / General / Tool tip help* – activates tool tip help

*Display / General / Separate hold of channel A and B* – the standard „hold“ controls on the main screen will be replaced by the ones, which allow separate hold of the channel A and B

*Display / Main screen / Allow display start change by dragging waveform* – the displayed part of the waveform on the oscilloscope screen can be changed by dragging waveform on the oscilloscope screen

*Display / Main screen / Allow vertical shift change by dragging waveform* – the vertical shift can be changed by dragging waveform on the oscilloscope screen

*Display / Main screen / Allow AT change by dragging mark* – the after trigger amount can be changed by dragging the trigger mark (red triangle)

*Display / Main screen / Autoset trigger mode when dragging mark* – when this option is on, the trigger mark drag automatically sets the trigger mode to „set“

*Display / Main screen / Show information on main screen* – the information about timebase, range and vertical cursors' distance will be displayed on the main screen

*Display / Main screen / Clear screen in single/manual mode on acq. start* – the screen is automatically cleared (all acquired waveforms are removed), when the acquisition is started by click on the „flag“ button (single or manual trigger mode).

*Display / Grid / Display ground level* – turns display of the ground on the screen on/off

*Display / Grid / Allow vertical shift change by dragging ground position* – the vertical shift can be changed by dragging the ground line

*Display / Grid / Allow vertical shift change by dragging grid* – if turned on, it is possible to drag the grid (horizontal lines) to set the vertical shift. This option is available only with the Dynamic vertical grid option on.

*Display / Grid / Allow display start change by dragging grid* – if turned on, it is possible to drag the grid (vertical lines) to set the display start.

*Display / Grid / Dynamic vertical grid position (ground on the line)* – if turned on, the grid position is automatically adjusted to keep ground of the channel A (or channel B if channel A is turned off) on the horizontal line

*Display / Grid / Dynamic horizontal grid position (trigger event on line)* – if turned on, the horizontal grid position will be adjusted to match the trigger event (one of the vertical lines will match the trigger event).

*Display / Grid / Display legend* – turns the grid legend on/off

*Display / Grid / Precise legend values* – if turned off, the legend values will be rounded to achieve best readability, otherwise they are rounded to three decimals

*Display / Quickview / Display quickview* – if more than 64k samples are acquired, quickview is displayed above oscilloscope screen

*Keyboard / General / Keyboard control* – enables/disables mode, which allows you to control some functions using keyboard. Please see chapter 4.14.4. for the list of supported functions.

*Keyboard / General / Distinguish between left and right shift/ctrl* – if this options is enabled, the left and right ctrl (or shift) are considered as different keys. If the keyboard control is disabled, this setting has no influence on the application.

*Keyboard / Hotkeys / Configure hotkeys* – opens the window, where you can configure hotkeys (see chapter 4.14.4.).

*Printing / Printing / Print in black and white* – enables/disables black and white printing

*Printing / Printing / Use application color scheme* – activates/deactivates printing in the application color scheme (the screen and channels will be printed in the application colors)

*Rendering / Waveform rendering / Enhanced xor draw* – activates/deactivates enhanced xor waveform drawing. The standard draw method produces dots instead of peaks, because the lines, which create waveform, xors themselves out. Enhanced drawing solves this problem, but requires more processor time.

*Automatic actions / Triggering / Set auto trigger mode, when the input is grounded* – if turned on, the software automatically sets “auto” trigger mode, when at least one input is grounded

*Automatic actions / Triggering / Move trigger level together with vertical shift* – if turned on, the software automatically sets trigger level to maintain its level in volts, when the vertical shift changes

*Automatic actions / Triggering / Move trigger level together with range* – if turned on, the software automatically sets trigger level to maintain its level in volts, when the range changes

*Automatic actions / Autosave / Deactivate autosave on startup* – if turned on, the autosave is always turned off on the application startup. This option defaults to on because of the safety issues (to prevent running out of hard drive space).

*Controls / Vertical / Display screen position in vertical position sliders* – if turned on, the main screen position is displayed in the vertical shift sliders

*Controls / Vertical / Calculate range with regard to probe attenuation* – if turned on, the probe attenuation information is included in the range information in vertical panel

### **4.3.2. Manage exports as ASCII window**

Click the item in the main menu to open „Manage exports“ window.

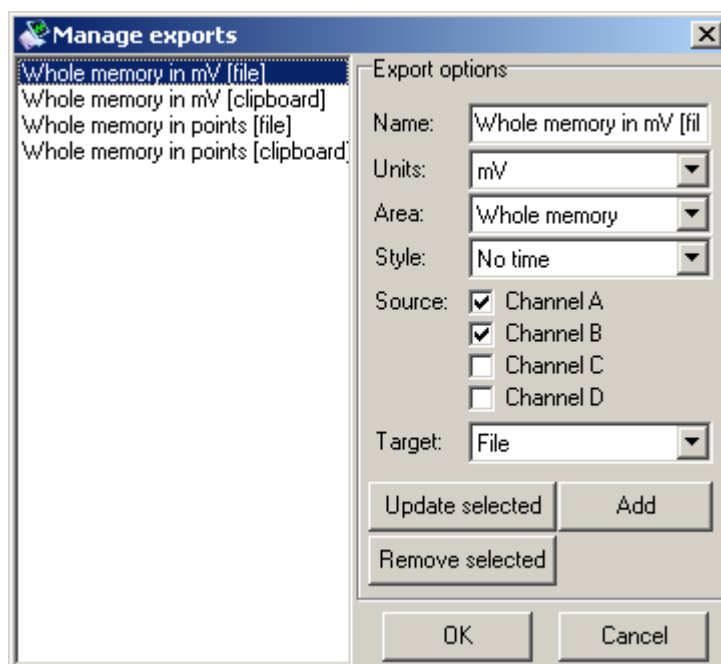

**Fig. 4.3.2.1. – Manage exports as ASCII window**

The list of all saved definition is in the left of the window. Click definition in the list to select it and fill the options in the right with it.

---

**TIP: The export items in the main menu are created in the order the definitions are in the list. Drag definition in the list to change its position.**

---

Each definition has following options:

*Name* – identifies definition in the main menu. Click menu item to export data using the definition.

*Units* – indicates, which units will be the data converted to. Following options are available:

*mV* – samples will be exported in mV

*V* – samples will be exported in V

*Points* – samples will be exported as number from 0 to 255

*Area* – indicates area, that will be exported. Following options are available:

*Whole memory* – whole memory will be exported

*Screen* – data on the oscilloscope screen will be exported

*Vertical cursors* – data between vertical cursors will be exported

*Style* – indicates style, which will be used to export data:

*No time* – exports each sample on the separate line and the tabulator is used as delimiter between channels. In case the data for the channel doesn't exist, the dash (,-,) is exported instead.

*Time in us* – exports each sample on the separate line. The time in us from trigger event is exported to the first column, selected channels are exported to following columns. In case the data for the channel doesn't exist, the dash (,-,) is exported instead.

*Source* – indicates source of the data for the export. Following options are available:

*Channel A* – channel A will be exported

*Channel B* – channel B will be exported

*Channel C* – channel C will be exported (first virtual channel)

*Channel D* – channel D will be exported (second virtual channel)

*Target* – indicates target of the export. Following options are available:

*Clipboard* – data will be exported to the clipboard

*File* – data will be exported to the file. The standard dialog window opens before the export, which will allow you to select target file.

Click „Update selected“ button to update selected definition.

Click „Remove selected“ button to remove selected definition.

Click „Add“ button to add the definition to the list.

Click „OK“ to update items in the main menu, which allows you to export data according to new definitions.

### 4.3.3. Manage exports as image window

Click the item in the main menu to open „Manage exports“ window.

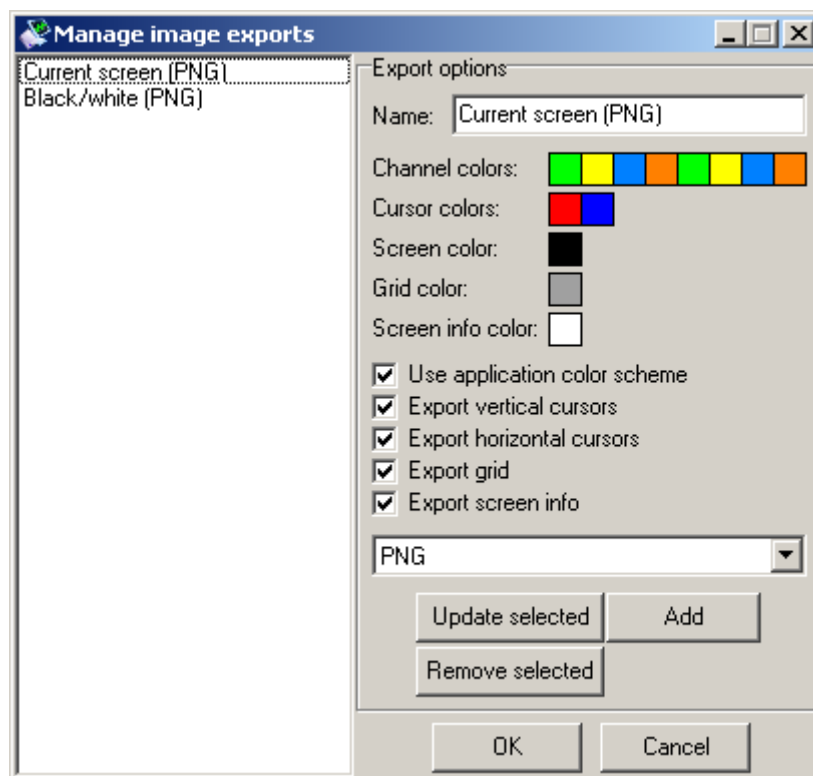

*Fig. 4.3.3.1. – Manage exports as image window*

The list of all saved definition is in the left of the window. Click definition in the list to select it and fill the options in the right with it.

---

**TIP: The export items in the main menu are created in the order the definitions are in the list. Drag definition in the list to change its position.**

---

Each definition has following options:

*Name* - identifies definition in the main menu. Click menu item to export data using the definition.

*Channel colors* – indicates the channel colors

*Cursor colors* – indicates the cursor colors

*Screen color* – indicates the screen background color

*Grid color* – indicates the grid color

*Screen info color* – indicates the color of the screen information (text)

---

**WARNING: In case the „Use application color scheme“ is turned on, all color settings have no effect.**

---

*Use application color scheme* – all export color settings will be overridden by application colors during export

*Export vertical cursors* – the vertical cursors will be exported (if they are on)

*Export horizontal cursors* – the horizontal cursors will be exported (if they are on)

*Export grid* – the grid will be exported (if it is on)

*Export screen info* – the screen information will be exported (if they are on)

The image format can be selected in the combobox:

PNG – the format with lossless compression

JPG – the format with lossy compression

BMP – the format with no compression

---

**TIP: In case you need to change the format often, select the format you are using most often. It is possible to change the format during the export.**

---

#### 4.3.4. Hotkeys window

The hotkeys window opens after the click on the „Configure hotkeys“ button in the „Options“ window. You can define hotkeys in this window.

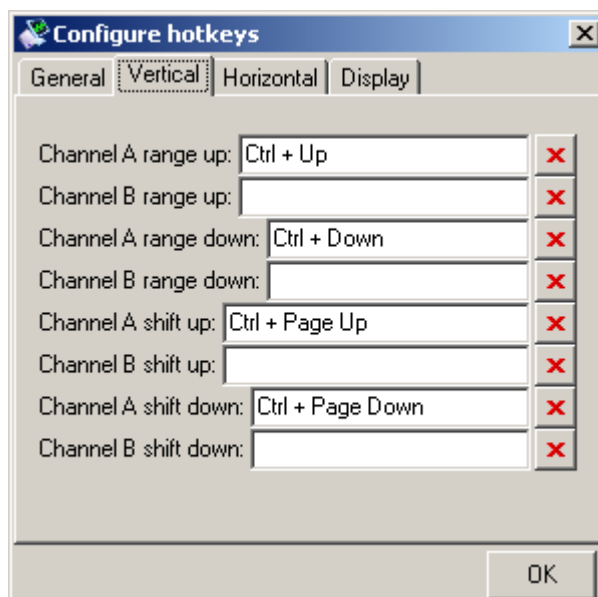

**Fig. 4.3.4.1. – The hotkeys window**

Following functions can be controlled using keyboard (the default value is specified in the brackets):

*General / Hold (ctrl + space)* – pauses the acquisition

*Vertical / Channel A range up (ctrl + up arrow)* – sets less sensitive range on the channel A

*Vertical / Channel B range up (no default)* – sets less sensitive range on the channel B

*Vertical / Channel A range down (ctrl + down arrow)* – sets more sensitive range on the channel A

*Vertical / Channel B range down (no default)* – sets more sensitive range on the channel B

*Vertical / Channel A shift up (ctrl + page up)* – shifts channel A upwards

*Vertical / Channel B shift up (no default)* – shifts channel B upwards

*Vertical / Channel A shift down (ctrl + page down)* – shifts channel A downwards

*Vertical / Channel B shift down (no default)* – shifts channel B downwards

---

**TIP: If you hold the hotkey for any shift function, the channel shifts until you release the hotkey.**

---

*Horizontal / Timebase up (ctrl + right arrow)* – sets faster timebase

*Horizontal / Timebase down (ctrl + left arrow)* – sets slower timebase

*Display / Zoom in (ctrl + + of numeric keyboard)* – zooms into the waveform

*Display / Zoom out (ctrl + - of numeric keyboard)* – zooms out of waveform

*Display / Move screen right (2 divs)* – moves waveform on the screen by 2 divisions to the left

*Display / Move screen left (2 divs)* – moves waveform on the screen by 2 divisions to the right

*Display / Move screen right (8 divs)* – moves waveform on the screen by 8 divisions to the left

*Display / Move screen left (8 divs)* – moves waveform on the screen by 8 divisions to the right

---

**TIP: If you hold the hotkey for any move function, the waveform moves until you release the hotkey.**

---

*Display / Clear screen* – clears whole screen (works in all display modes)

*Display / Clear fading* – clears old waveforms (fading) in the fading mode (works only in fading mode)

Click the edit box and push the hotkey to redefine hotkey for any function. Click  if you want to remove hotkey for specified function.

## 5. Other functions

### 5.1. Print Support

To open the print manager window, click the “Print” item of the [main menu](#). The black and white printing can be turned on/off in the options window (please see chapter 4.14.1.).

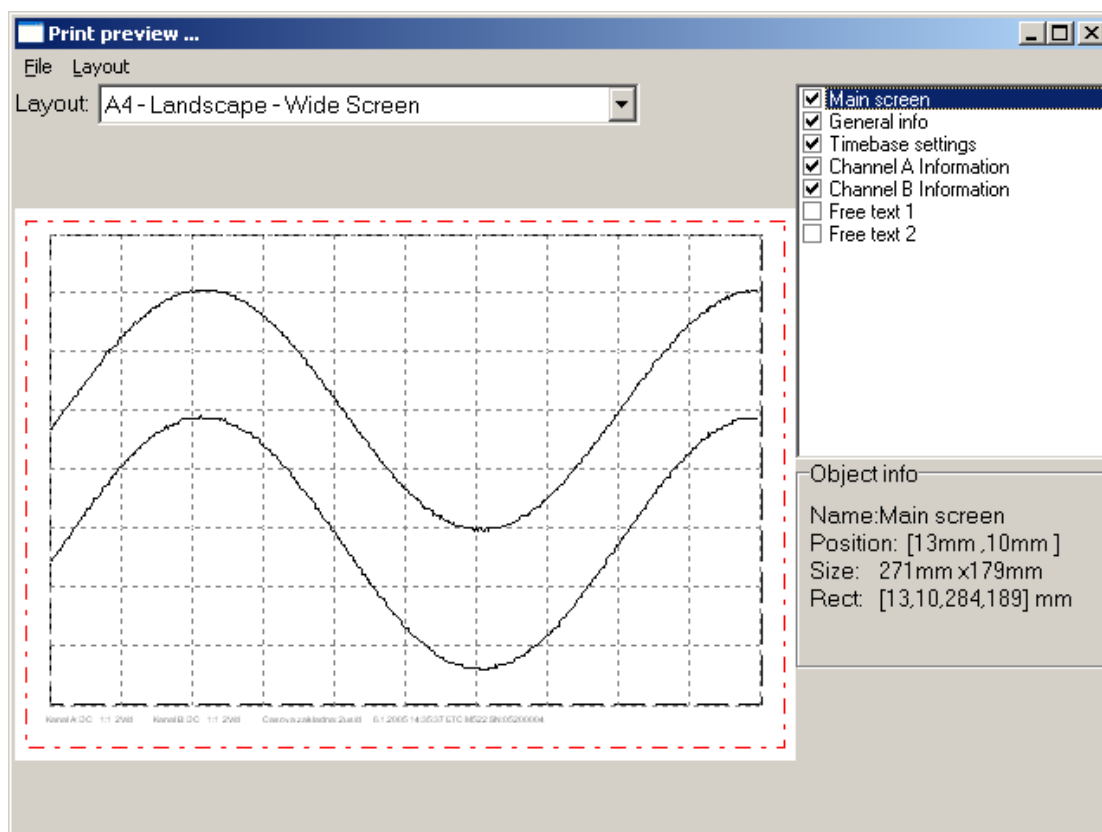

**Fig. 5.1.1. - Print Manager Window**

On the left side of the window the page is previewed as it will be printed. Several important parts of the page are highlighted. The lines marking these parts will not be printed. The red line outlines the printable area of the page. Selected object is marked by black dashed outline.

To select an object, click it. You can move it into a desired position by dragging it. To change the size of a chosen object, drag its outline.

In the lower right corner of the window the following information on the properties of the selected object is shown:

- “Name” – Name of the object
- “Position” – Coordinates of the upper-left corner of the object on the page in millimeters
- “Size” – Size of the object in millimeters



“Rect” – Position of the upper-left corner and the lower-right corner on the page in millimeters

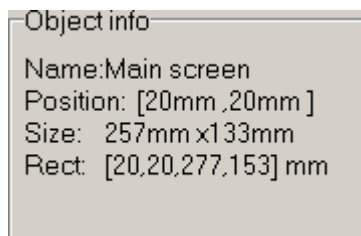

**Fig. 5.1.2. - Object Info**

In the upper-right corner of the window names of all the objects that can be placed into the page are listed. To display/hide an object, click the box next to the object name. To select an object, click the name of the object (if the object is displayed).

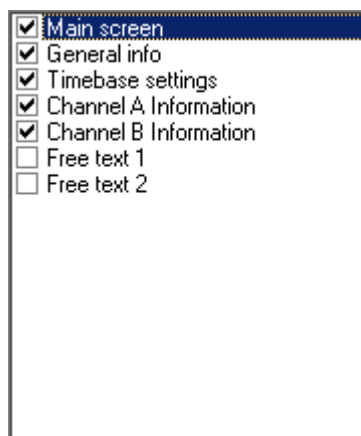

**Fig. 5.1.3. - List of available objects**

---

**TIP: Two objects with content that can be specified by the user are available (objects “Free text 1” and “Free text 2”). Double-clicking any of these objects opens a dialog window to insert the text to be displayed.**

---

It is possible to select automatic layout and predefined schemes of object display in the “Layout” combo-box. Choosing the “Custom” item does not affect the current layout.

---

**WARNING: In the “Layout” combo-box only the layouts available for the current paper size are shown.**

---

It is possible to save a modified layout under the current name choosing the “Layout / Save layout” item of the main menu of this window. To save it under a different name, choose “Layout / Save layout as”. A dialog box will appear to insert the name for the new layout.

Following are the other items Layout menu consists of:

„*Layout / Manage layouts*” – Opens the Layout manager window.

„*File / Printer setup*“ – Opens the printer settings window

„*File / Print*“ – Prints the page

„*File / Close*“ – Terminates the print manager

### 5.1.1. Setting the name of a new layout

To open the Specify layout name dialog window, select the “*Layout / Save layout as*” item. Now you can enter the name of the new scheme.

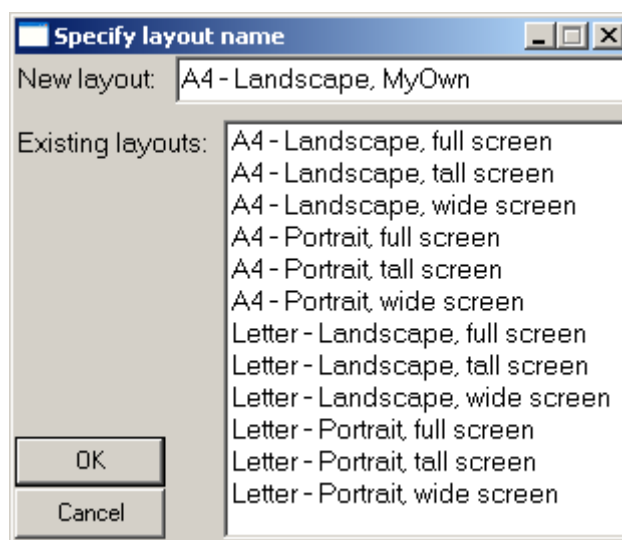

**Fig. 5.1.1.1. - Specify Layout Name Window**

It is necessary to insert a name of the new layout into the “New layout” box. This name has to differ from the names of the existing layouts. If the name would be identical with the name of another layout, this layout would be replaced by the new layout. At the same time the existing layout would be highlighted in the layout list. If you click a name of a layout in the list, this name will appear in the “New layout” box.

To save the layout, click the OK button.

### 5.1.2. Layout Manager

To open the Layout Manager window, select the “*Layout / Manage layouts*” item in the main menu of the print manager window.

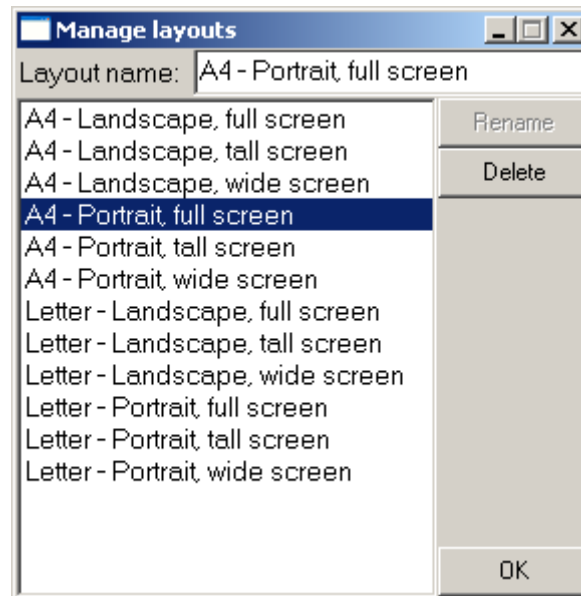

***Fig. 5.1.2.1. - Layout Manager Window***

To select a layout, double-click its name in the list.

To erase the selected layout, click the “Delete” button.

To rename a layout, select it, insert the new name into the “Layout name” box and then click the “Rename” button.

## 6. Special functions

### 6.1. 80% function (80%)

The horizontal cursors' positions are affected as follows:

Lower horizontal cursor is moved upwards by 10% of the distance between cursors and the upper one is moved downwards by same 10%.

### 6.2. Channel difference function (A-B)

The function result depends on the reference cursor state:

1. Reference cursor active: function calculates difference between the channel A and channel B, where the reference cursor level is considered to be zero. The result of the zero value is displayed on the reference cursor position.

2. Reference cursor inactive: function calculates difference of the channel A and channel B, where the 0V level is considered to be zero. The result of the zero value is displayed in the middle of the screen (between fourth and fifth division).

### 6.3. Channel add function (A+B)

The function result depends on the reference cursor state:

1. Reference cursor active: function adds channel A and channel B, where the reference cursor level is considered to be zero. The result of the zero value is displayed on the reference cursor position.

2. Reference cursor inactive: function adds channel A and channel B, where the 0V level is considered to be zero. The result of the zero value is displayed in the middle of the screen (between fourth and fifth division).

### 6.4. Channel A inversion (-A)

Function calculates inversion of the channel A (with no respect to 0V).

### 6.5. Channel B inversion (-B)

Function calculates inversion of the channel B (with no respect to 0V).

### 6.6. Channel A voltage inversion (-VA)

Function calculates channel A inversion, where the reference cursor position is considered as a zero value (reference cursor on) or the 0V is considered as a zero value (reference cursor off).

### 6.7. Channel B voltage inversion (-VB)

Function calculates channel B inversion, where the reference cursor position is considered as a zero value (reference cursor on) or the 0V is considered as a zero value (reference cursor off).

## 6.8. X-Y function (X/Y)

The X-Y function window is opened after an activation of the X-Y function.

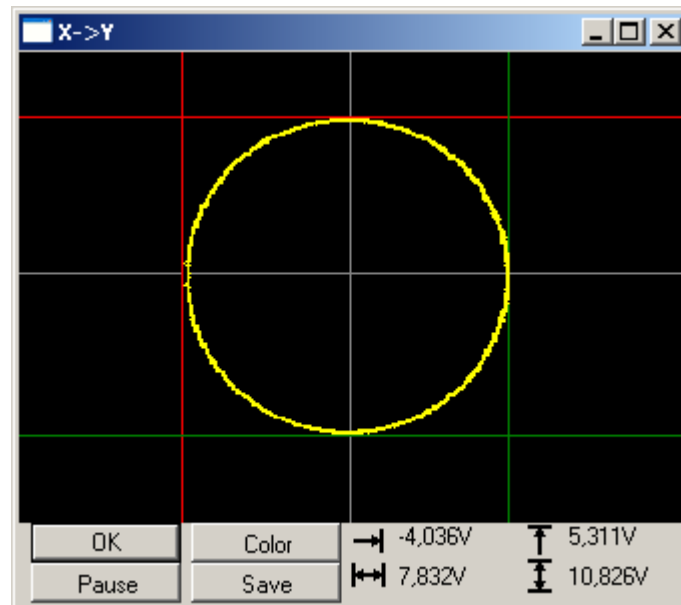

*Fig. 6.8.1. – X-Y function window*

---

**TIP: The X-Y function window stays always on top. Therefore it is possible to change oscilloscope settings and see their influence immediately.**

---

The 0V values for X-axis and Y-axis are displayed in gray color.

---

**TIP: The 0V positions can be changed by vertical shift for both axis.**

---

Two horizontal and two vertical cursors are available. Drag them to change their position.

---

**TIP: The X-Y function displays the data visible on the main screen. Zoom function affects amount of displayed data.**

---

The cursors' position information are displayed in lower right corner of the window:

- - voltage between red vertical cursor and 0V
- ↔ - voltage between vertical cursors
- ↑ - voltage between red horizontal cursor and 0V
- ⇅ - voltage between horizontal cursors

“Color” – opens standard operating system dialog, where you can select the shape color

“Save” – saves shape in .jpg format.

“Pause” – pauses shape updating

## 6.9. Fourier transformation function (FT)

The fourier transformation transforms acquired samples using fourier transformation. The FFT (fast fourier transformation) and DFT (discrete fourier transformation) are implemented. In case the automatic period selection is activated, one period of waveform is transformed, otherwise the part distinguished by cursors in oscilloscope software is transformed.

The fourier transformation window is opened after activation of the FT function.

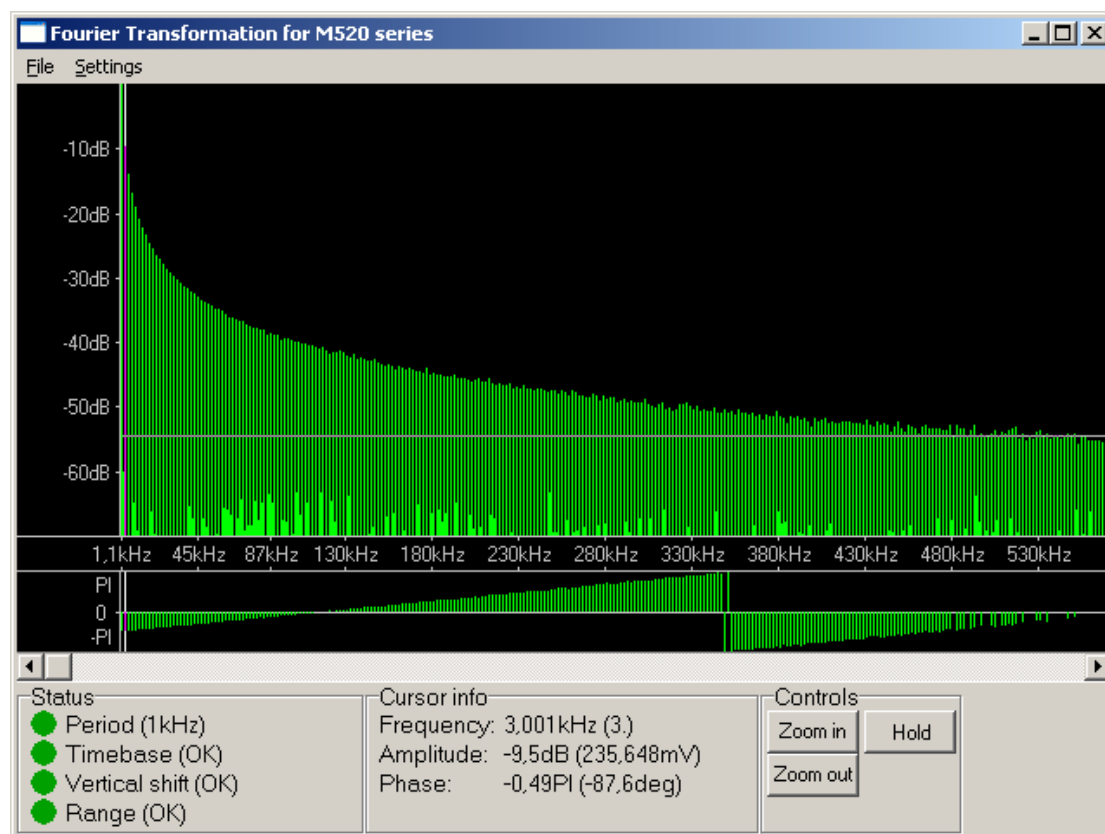

**Fig. 6.9.1. – Fourier transformation window**

The main screen is located in the top of the window. The frequency bar divides it into two parts. You can change the parts' size by dragging this bar. The harmonics' amplitude is displayed in the top part (amplitude part), the phase in bottom one.

The threshold amplitude is represented by grey horizontal line in the amplitude part. You can change threshold by dragging this line. Phase is displayed only for the harmonics with amplitude above this threshold.

If the decibels amplitude mode is activated, you can change amplitude range by dragging ticks in the left of the amplitude part.

The watched harmonic can be selected by vertical grey cursor.

You can scroll data using the scroll bar located below main screen.

The status panel with information about analyzed signal is located in the left bottom corner of the main window.

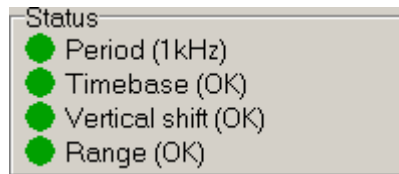

**Fig. 6.9.2. – Status panel**

If the indicator „Period“ is:

red – application was not able to find period automatically

green – period found successfully

grey – the manual selection of period is activated

The current selected period is displayed in parentheses.

If the indicator „Timebase“ is:

red, yellow – the timebase is too slow for analyzed signal, faster timebase will produce better results

green – suitable timebase is set

grey – the automatic period selection is deactivated

If the indicator „Vertical shift“ is:

red – vertical shift is not suitable. If the „Up“ is in parentheses, the waveform is shifted up, „Down“ – waveform is shifted down.

green – suitable vertical shift is set.

If the indicator „Range“ is:

red – range is not suitable. If the „Sensitive“ is in parentheses, sensitive range is set, „Insensitive“ – insensitive range is set.

green – suitable range is set.

The information about harmonic selected by cursor are displayed in the bottom of the main window.

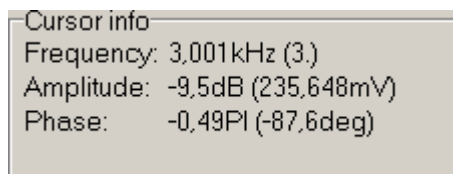

**Fig. 6.9.3. – Information about harmonic selected by cursor**

„Frequency“ – Frequency of harmonic (its index)

„Amplitude“ – Amplitude of harmonic in decibels (in voltage)

„Phase“ – Phase of harmonic in radians (in degrees)

---

**TIP: The effective or peak voltage of harmonic can be displayed. You can select it in main menu.**

---

The main screen controls are located in the right bottom corner of the main window.

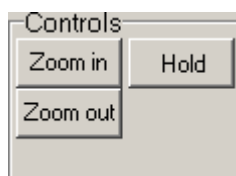

*Fig. 6.9.4. – Screen controls*

Click „Hold“ button to pause/unpause data refresh. Click „Zoom in“ to display less data on the screen, click „Zoom out“ to display more.

---

**TIP: You can zoom in/out using mouse wheel: if the mouse cursor is over amplitude part of screen, rotation of wheel from you zooms in, to you zooms out. The position of harmonic below mouse cursor remains intact after zoom (if possible).**

---

### 6.9.1. Main menu

The main menu is located in the top of the window. Following items are available:

*File / Print* – Opens the print manager

*Settings / Data source / Channel A* – Sets channel A as data source

*Settings / Data source / Channel B* – Sets channel B as data source

*Settings / Period selection / Automatic* – Activates automatic period selection

---

**WARNING: Automatic period selection can fail to find period of some signals. If you are not sure, whether found period is correct, select period by cursors and activate one of manual modes.**

---

*Settings / Period selection / Manual with fine shift* – The period selected by cursors are automatically adjusted to match period. The period is adjusted maximally by  $\pm 2$  points of scope screen.

---

**TIP: Manual mode with fine shift is suitable if you need to select signal period longer than 500 samples. It is not possible to select period with precision of one sample in manual mode if there is more than 500 samples on the oscilloscope screen.**

---

*Settings / Period selection / Manual* – The period is selected by vertical cursors

---

**WARNING: It is not possible to select period with precision of one sample in manual mode if there is more than 500 samples on the oscilloscope screen, because one screen point corresponds with more than one acquired sample. The manual mode with fine shift is suitable for most measurements.**

---



---

**TIP: The more samples will be period composed of, the more precise results will be achieved.**

---



*Settings / Algorithm / FFT* – Data will be transformed by fast fourier transformation.

*Settings / Algorithm / DFT* – Data will be transformed by discrete fourier transformation.

---

**TIP: The FFT is suitable for most measurements. DFT is suitable for extremely high precise measurements only: FFT with very high quality is essentially same as DFT.**

---

*Settings / FFT quality / Normal* – Sets normal FFT quality. This quality distorts harmonics near half of sampling frequency.

*Settings / FFT quality / High* - Sets high FFT quality. This quality little distorts harmonics near half of sampling frequency.

*Settings / FFT quality / Very high* – Sets very high FFT quality. The result is essentially same as it were transformed using DFT.

---

**WARNING: FFT with normal quality lowers amplitude of harmonics near half of sampling frequency. We do recommend to use DFT for precise measurements of these frequencies (or FFT with very high quality, if fast transformation is desired).**

---

*Settings / Amplitude mode / Decibels* – Displays harmonics' amplitudes in logarithmic mode, where 0dB is amplitude of harmonic with the highest energy.

*Settings / Amplitude mode / Voltage* – Displays harmonics' amplitudes in linear mode in voltage.

*Settings / Voltage mode / Amplitude* – Voltage will represent amplitude of harmonic.

*Settings / Voltage mode / Effective* – Voltage will represent effective voltage of harmonic.

*Settings / Stay on top* – Activates/deactivates always on top mode of main window.

Following items control inverse fourier transformation (IFT). It is necessary to activate IFT to use them.

*Filter / Mode / Surpress noise* – The harmonics with level higher than the threshold will be used for inverse fourier transformation.

*Filter / Mode / Simple* – Inverse fourier transformation is calculated from selected harmonics. Hold ctrl and click on harmonics to select/deselect it. Hold shift and double click on screen to select/deselect all harmonics.

*Filter / Mode / Complex* – The harmonics are modified by filter specified before IFT calculation. Therefore, the result represents the input waveform pass through specified filter. You can specify filter by clicking on the item in main menu.

*Filter / Algorithm / FFT* – Data will be transformed by inverse fast fourier transformation.

*Filter / Algorithm / DFT* – Data will be transformed by inverse discrete fourier transformation.

---

**WARNING: The inverse FFT algorithm has negative effect on the waveform quality. To achieve best results, use DFT on both transformations (inverse fourier transformation and fourier transformation).**

---

*Filter | FFT Quality | Normal* – Sets normal quality of the inverse FFT.

*Filter | FFT Quality | High* – Sets high quality of the inverse FFT.

*Filter | FFT Quality | Very high* – Sets very high quality of the inverse FFT.

---

**WARNING: Inverse FFT quality settings affect only inverse fourier transformation. Change parameters of the fourier transformation to eliminate errors caused by the fourier transformation.**

---

*Filter | Configure complex filter* – Opens the configure complex filter window.

## 6.9.2. Complex filter window

The complex filter window is opened after click on the main menu item.

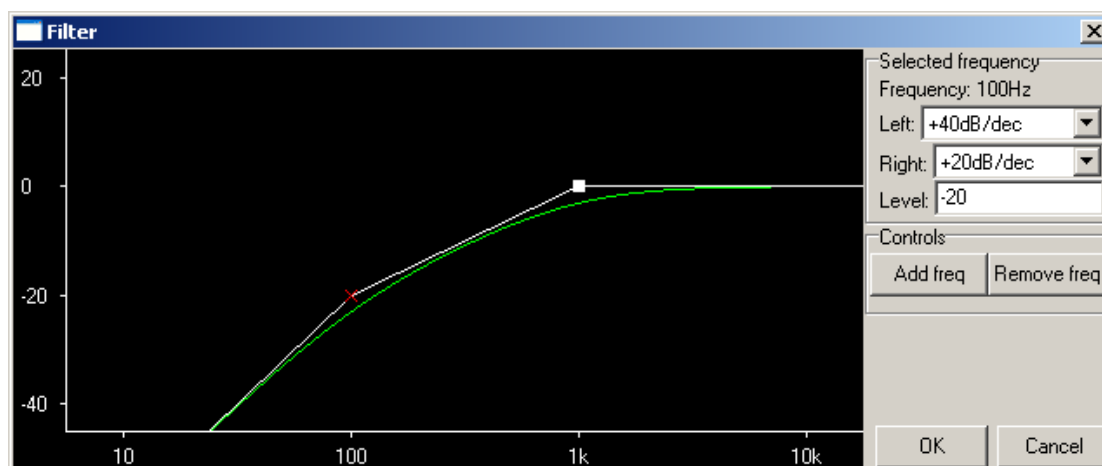

*Fig. 6.9.2.1. – Complex filter window*

The filter graph is displayed in the left part of the window. Cut frequencies are marked by a cross or square. Software composes real filter from RC filters with specified cut frequencies. Real filter is displayed in green.

Cut frequency marked by cross has its level fixed. Other frequencies' levels (marked by square) are calculated from fixed frequency level.

Click cross or square to selected cut frequency. Selected cut frequency is displayed in red.

The selected frequency controls are located in right of the window.

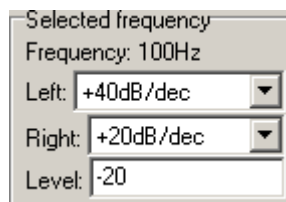

**Fig. 6.9.2.2. – Selected frequency controls**

Click „left“ combobox to change filter steepness below selected frequency, click „right“ combobox to change filter steepness above selected frequency.

It is possible to set attenuation at specified frequency in „level“ edit box. The frequency's level become fixed after this operation.

Frequencies controls are located in the bottom left corner of the window.



**Fig. 6.9.2.3. – Frequencies controls**

Click „Remove freq“ button to delete selected frequency.

Click „Add freq“ button to open a window, where you can select new cut frequency.

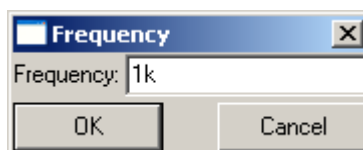

**Fig. 6.9.2.4. – New frequency window**

It is necessary to enter desired frequency into „Frequency“ edit box.

---

**TIP: It is possible to enter value into „Frequency“ edit box with power of ten (for example 1k = 1000). It is possible to use k – kilo and M – mega.**

---

## 6.10. Inverse fourier transformation function (IFT)

This function calculates inverse fourier transformation from the data calculated by fourier transformation module (FT).

---

**WARNING: You can use this function only together with FT function. If the FT function is not activated, it is not possible to activate IFT function.**

---

All IFT settings are accessible through FT module's main menu.

## 6.11. Waveform parameters function (Wp)

Waveform parameters function calculates parameters of the channel A, B, C or D waveform.

The window opens after module activation.

		now (A)	avg (A)	now (C)	avg (C)
X	Peak-peak	6,562 V	6,531 V	7,562 V	7,562 V
X	Peak+	3,188 V	3,183 V	3,688 V	3,688 V
X	Peak-	-3,375 V	-3,347 V	-3,875 V	-3,875 V
X	Frequency	10,580 kHz	10,579 kHz	10,578 kHz	10,579 kHz
X	Period	94,52 us	94,524 us	94,54 us	94,524 us
X	DC voltage	-86,318 mV	-88,326 mV	-88,256 mV	-89,073 mV
X	Vrms	3,152 V	3,153 V	3,133 V	3,134 V
X	Vavg	3,150 V	3,151 V	3,110 V	3,112 V
X	Crest factor	96,064 %	96,564 %	82,851 %	82,886 %
X	High pulse width	47,18 us	47,164 us	45,86 us	45,869 us
X	Low pulse width	47,18 us	47,162 us	45,88 us	45,864 us
X	Duty factor	50,000 %	50,007 %	50,011 %	50,000 %
X	High pulse level	3,066 V	3,065 V	3,055 V	3,055 V
X	Low pulse level	-3,239 V	-3,242 V	-3,231 V	-3,233 V
X	High overshoot	1,925 %	1,868 %	10,064 %	10,060 %
X	Low overshoot	2,156 %	1,668 %	10,245 %	10,205 %
X	Rise time	60 ns	79,200 ns	1,38 us	1,375 us
X	Fall time	60 ns	78,200 ns	1,38 us	1,375 us

**Fig. 6.11.1. – Waveform parameters window**

Following parameters are displayed in the table:

- „Peak-peak“ – peak-peak voltage
- „Peak+“ – voltage of the maximum
- „Peak-“, – voltage of the minimum
- „Frequency“ – frequency
- „RPM“ – frequency/60 (revolutions per minute)
- „Period“ – period
- „DC voltage“ – DC voltage
- „Vrms“ – effective voltage
- „Vavg“ – average voltage
- „Crest factor“ – crest factor

If the module fails to detect periodicity of the waveform, „N/A“ is displayed in the place of „Frequency“, „Period“, „DC voltage“, „Vrms“, „Vavg“, „Crest factor“.

- „High pulse width“ – high pulse width
- „Low pulse width“ – low pulse width
- „Duty factor“ – duty factor
- „High pulse level“ – level of the high pulse
- „Low pulse level“ – level of the low pulse
- „High overshoot“ – overshoot of the leading edge
- „Low overshoot“ – overshoot of the trailing edge
- „Rise time“ – length of the leading edge
- „Fall time“ – length of the trailing edge

If the module fails to detect periodicity or rectangular shape of the waveform, „N/A“ is displayed in the place of „High pulse width“, „Low pulse width“, „Duty factor“, „High pulse level“, „Low pulse level“, „High overshoot“, „Low overshoot“, „Rise time“, „Fall time“.

Time between 10% and 90% of the voltage between low and high pulse is considered to be length of the edge.

Click cross at the left side of the parameter name to hide it.

It is possible to display following statistics for each parameter:

- „now“ – current value of the parameter
- „min“ – minimal value of the parameter
- „max“ – maximal value of the parameter
- „avg“ – average value of the parameter
- „dev“ – parameter deviation

---

**WARNING: The statistics are calculated from whole history of the waveform. Click item in main menu to reset them.**

---

### 6.11.1. – Main menu

Main menu is located in top of the window. Following items are available:

*Edit / Copy* – Copies table to clipboard in text format.

*Edit / Reset params* – Resets statistics of all parameters.

*Settings / Channel C range source* – Channel C parameters will be calculated using range of selected channel.

*Settings / Channel D range source* – Channel D parameters will be calculated using range of selected channel

*Settings / Stay on top* – Activates/deactivates mode always on top mode of the window.

*Row / Show* – Shows/hides selected parameter

*Row / Show only* – Shows selected parameters and hides others.

*Row / Show all* – Shows all parameters

*Row / Configure rows* – Opens the window, where it is possible to show/hide parameters.

*Column / Channel* – Activates/deactivates selected channel parameters

*Column / Show* – Shows/hides selected statistic

*Column / Show only* – Shows selected statistic and hides others.

*Column / Show all* – Shows all statistics.

*Column / Configure columns* – Opens the window, where it is possible to activate/deactivate channels and show/hide statistics.

### 6.12. Phase shift calculation (Pf)

Phase shift calculation (Pf) calculates the phase shift between channel A and B. The window is displayed after the module is activated.

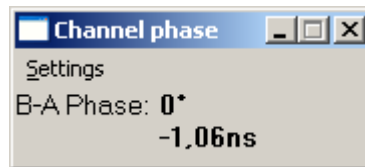

*Fig. 6.12.1. – Phase shift window*

The information about phase in degrees and time is displayed in the window. In case the channel A and B waveforms have different period, N/A is displayed.

---

**WARNING: Software uses first harmonic to detect the phase shift of the channels. In case the waveform of channel A or B is corrupted, the wrong phase can be calculated.**

---

The main menu is located in the top of the window. The following items are available:

*Settings / Stay on top* - Activates/deactivates mode always on top mode of the window.

## 7. Performance characteristics

### 7.1. M570 series performance characteristics

#### 7.1.1. Vertical deflection system

No of divisions	8
No of pixels per division	32
Deflection factor range	10mV/div to 5V/div in 1-2-5 sequence
Accuracy	+/- 2% of current value + 1 pixel
Resolution	8 bits (0,39%)
Frequency response (-3dB)	DC: 0 - 150 MHz, AC: 1.2Hz – 150 MHz
Step response rise time	max. 2.4 ns
Channel isolation	min. -60 dB
Resistance	1 MOhm +5 %, -2 %
Input resistance inaccuracy adjustment	Digital for absolute accuracy +/- 2% of current voltage + 1 pixel
Capacitance	29 pF +/- 1pF
Zero setting accuracy	+/- 2% of the screen
Maximum input voltage	+/- 200V at 100 kHz or less

*Table 7.1.1.1. – Vertical deflection system*

#### 7.1.2. Triggering

System type	Dual level
Trigger source for primary level	selectable Channel A, Channel B or external trigger input
Trigger source for secondary level	selectable Channel A, Channel B or external trigger input
Threshold setting	Channel A and Channel B on the whole display range. External fixed on about 1.5V
Slope selection	Leading or trailing edge independently on each source
Minimum trigger pulse period	5 ns
Minimum trigger pulse length	2.5 ns
Maximum voltage on external trigger input	-10V to +13V at 20 kHz or less
Adjustments	Digital filter with ability of setting the valid pulse length up to 131072*Ts for each level and counter of valid triggering events settable from 1 to 32768 for each level. HOLD-OFF settable up to 1048576*Ts with selectable AUTO mode, to sample proper amount of data before trigger. (Ts – actual real time sampling period)

*Table 7.1.2.1. – Triggering*

### 7.1.3. Data acquisition system

No of divisions	10
No of pixels per division	50
Mode of operation	Sampling before and after trigger with continual selection of the trigger position
Record length	settable from 1024 to 1048576 (1M) samples for each channel
Time base range in 1:1 mode	5 ns/d to 100 ms/d in 1-2-5 sequence
Time base range using different ZOOM modes	625 ps/d to 204.8 s/d
Time base accuracy	0.01 % to 100ns/d, 0.5 % for 50ns/d to 5 ns/d
Real time sampling frequency	500 Hz to 100 MHz
Equivalent sampling frequency	500 Hz to 10 GHz
Display range with respect to trigger event	1048576 samples before and 1048576 samples after trig. event in length of 1048576 samples

*Table 7.1.3.1. – Data acquisition system*

### 7.1.4. Probe compensation generator

Output connector	BNC, together with External trigger input
Output impedance	1 kOhm to parallel with 10nF and approx. 50 Ohm serial
Output waveform	Pulse with 1:1 duty cycle
Frequency	1465 Hz
Output voltage (no load)	3.3V +- 5%

*Table 7.1.4.1. – Compensation generator*

### 7.1.5. Power

Power source	USB interface via USB cable
Max current	USB1.1 – 350mA; USB2.0 – 450mA

*Table 7.1.5.1. - Power*

### 7.1.6. Mechanical characteristics

Dimensions without feet and connectors	165 x 111 x 35 mm
Dimensions with feet and connectors	182 x 111 x 39 mm
Weight	520 g

*Table 7.1.6.1. – Mechanical characteristics*

### 7.1.7. M574 timebase ranges

No	REAL TIME	t/div 1:16	t/div 1:1	t/div 10:1	Max. ACQ. TIME	SAMP. PERIOD	SAMP. FREQ.



1	no	10.24us	5ns	500ps	102.4us	100ps	10GHz
2	no	20.48us	10ns	1ns	204.8us	200ps	5GHz
3	no	40.96us	20ns	2ns	409.6us	400ps	2.5GHz
4	no	102.4us	50ns	5ns	1.024ms	1n	1GHz
5	no	204.8us	100ns	10ns	2.048ms	2n	500MHz
6	no	409.6us	200ns	20ns	4.096ms	4ns	250MHz
7	yes	1.024ms	500ns	50ns	10.24ms	10ns	100MHz
8	yes	2.048ms	1us	100ns	20.48ms	20ns	50MHz
9	yes	4.096ms	2us	200ns	40.96ms	40ns	25MHz
10	yes	10.24ms	5us	500ns	102.4ms	100ns	10MHz
11	yes	20.48ms	10us	1us	204.8ms	200ns	5MHz
12	yes	40.96ms	20us	2us	409.6MS	400ns	2.5MHz
13	yes	102.4ms	50us	5us	1.024s	1us	1MHz
14	yes	204.8ms	100us	10us	2.048s	2us	500kHz
15	yes	409.6ms	200us	20us	4.096s	4us	250kHz
16	yes	1.024s	500us	50us	10.24s	10us	100kHz
17	yes	2.048s	1ms	100us	20.48s	20us	50kHz
18	yes	4.096s	2ms	200us	40.96s	40us	25kHz
19	yes	10.24s	5ms	500us	102.4s	100us	10kHz
20	yes	20.48.s	10ms	1ms	204.8s	200us	5kHz
21	yes	40.96s	20ms	2ms	409.6s	400us	2.5kHz
22	yes	102.4s	50ms	5ms	1024s	1ms	1kHz
23	yes	204.8s	100ms	10ms	2048s	2ms	500Hz

Table 7.1.7.1. – M574 timebase ranges

## 7.2. M520 series performance characteristics

### 7.2.1. Vertical deflection system

No of divisions	8	
No of pixels per division	32	
Deflection factor range	10mV/div to 5V/div in 1-2-5 sequence	
Accuracy	+- 2% of current value + 1 pixel	
Resolution	8 bits (0,39%)	
Frequency response (-3dB)	M521, M522 M523, M524 M525, M526	DC: 0 - 60 MHz, AC: 1.2Hz - 60MHz DC: 0 - 120 MHz, AC: 1.2Hz – 120MHz DC: 0 – 150 MHz, AC: 1.2Hz – 150MHz
Step response rise time	M521, M522 M523, M524 M525, M526	max. 5.8 ns max. 2.9 ns max. 2.4 ns
Channel isolation	min. -75 dB	
Resistance	1 MOhm +5 %, -2 %	
Input resistance inaccuracy adjustment	Digital for absolute accuracy +- 2% of current voltage + 1 pixel	
Capacitance	30 pF +- 1pF	
Zero setting accuracy	+- 2% of the screen	
Maximum input voltage	+- 200V at 100 kHz or less	

**Table 7.2.1.1. – Vertical deflection system****7.2.2. Triggering**

System type	Dual level
Trigger source for primary level	selectable Channel A, Channel B or external trigger input
Trigger source for secondary level	selectable Channel A, Channel B or external trigger input
Threshold setting	Channel A and Channel B on the whole display range. External fixed on about 1.5V
Slope selection	Leading or trailing edge independently on each source
Minimum trigger pulse period	5 ns
Minimum trigger pulse length	2.5 ns
Maximum voltage on external trigger input	–10V to +13V at 20 kHz or less
Adjustments	Digital filter with ability of setting the valid pulse length up to 131072*Ts for each level and counter of valid triggering events settable from 1 to 32768 for each level. HOLD-OFF settable up to 131072*Ts with selectable AUTO mode, to sample proper amount of data before trigger. (Ts – actual real time sampling period)

**Table 7.2.2.1. – Triggering****7.2.3. Data acquisition system**

No of divisions	10	
No of pixels per division	50	
Mode of operation	Sampling before and after trigger with continual selection of the trigger position	
Record length	M521, 3, 5 M522, 4, 6	4096 samples for each channel 8192 samples for each channel
Time base range in 1:1 mode	M521, M522 M523, M524 M525, M526	10 ns/d to 100 ms/d in 1-2-5 sequence 5 ns/d to 100 ms/d in 1-2-5 sequence 2 ns/d to 100 ms/d in 1-2-5 sequence
Time base range using different ZOOM modes	M521 M522 M523 M524 M525 M526	1 ns/d to 400 ms/d 1 ns/d to 800 ms/d 500 ps/d to 400 ms/d 500 ps/d to 800 ms/d 200 ps/d až 800 ms/d 200 ps/d až 1.6 s/d
Time base accuracy	0.01 % to 100ns/d, 0.5 % for 50ns/d to 5 ns/d	
Real time sampling frequency	M521, M522 M523, M524 M525, M526	500 Hz to 50 MHz 500 Hz to 100 MHz 500 Hz to 200 MHz
Equivalent sampling frequency	M521, M522 M523, M524	500 Hz to 5 GHz 500 Hz to 10 GHz

	M525, M526	500 Hz to 20 GHz
Display range with respect to trigger event	M521, M523, M525, M522, M524, M526	4094 samples before and 63000 samples after trig. event in length of 4096 samples 8190 samples before and 63000 samples after trig. event in length of 8192 samples

*Table 7.2.3.1. – Data acquisition system*

#### 7.2.4. Probe compensation generator

Output connector	BNC, together with External trigger input
Output impedance	1 kOhm to parallel with 10nF and approx. 50 Ohm serial
Output waveform	Pulse with 1:1 duty cycle
Frequency	1465 Hz
Output voltage (no load)	3.3V +- 5%

*Table 7.2.4.1. – Compensation generator*

#### 7.2.5. Power

Power source	USB interface via USB cable
Max current	USB1.1 – 350mA; USB2.0 – 450mA

*Table 7.2.5.1. - Power*

#### 7.2.6. Mechanical characteristics

Dimensions without feet and connectors	165 x 111 x 35 mm
Dimensions with feet and connectors	182 x 111 x 39 mm
Weight	520 g

*Table 7.2.6.1. – Mechanical characteristics*

#### 7.2.7. M521 timebase ranges

No	REAL TIME	t/div 1:8	t/div 1:1	t/div 10:1	ACQ. TIME	SAMP. PERIOD	SAMP. FREQ.
2	no	80ns	10ns	1ns	8.196us	200ps	5GHz
3	no	160ns	20ns	2ns	1.638us	400ps	2.5GHz
4	no	400ns	50ns	5ns	4.096us	1n	1GHz
5	no	800ns	100ns	10ns	8.192us	2n	500MHz
6	no	1.6us	200ns	20ns	16.38us	4ns	250MHz
7	no	4us	500ns	50ns	40.96us	10ns	100MHz
8	yes	8us	1us	100ns	81.96us	20ns	50MHz
9	yes	16us	2us	200ns	163.8us	40ns	25MHz
10	yes	40us	5us	500ns	409.6us	100ns	10MHz
11	yes	80us	10us	1us	819.2us	200ns	5MHz
12	yes	160us	20us	2us	1.638ms	400ns	2.5MHz
13	yes	400us	50us	5us	4.096ms	1us	1MHz
14	yes	800us	100us	10us	8.192ms	2us	500kHz
15	yes	1.6ms	200us	20us	16.38ms	4us	250kHz

16	yes	4ms	500us	50us	40.96ms	10us	100kHz
17	yes	8ms	1ms	100us	81.92ms	20us	50kHz
18	yes	16ms	2ms	200us	163.8ms	40us	25kHz
19	yes	40ms	5ms	500us	409.6ms	100us	10kHz
20	yes	80ms	10ms	1ms	819.2ms	200us	5kHz
21	yes	160ms	20ms	2ms	1.638s	400us	2.5kHz
22	yes	400ms	50ms	5ms	4.096s	1ms	1kHz
23	yes	800ms	100ms	10ms	8.192s	2ms	500Hz

*Table 7.2.7.1. – M521 timebase ranges*

### 7.2.8. M522 timebase ranges

No	REAL TIME	t/div 1:16	t/div 1:1	t/div 10:1	ACQ. TIME	SAMP. PERIOD	SAMP. FREQ.
2	no	160ns	10ns	1ns	1.638us	200ps	5GHz
3	no	320ns	20ns	2ns	3.276us	400ps	2.5GHz
4	no	800ns	50ns	5ns	8.192us	1n	1GHz
5	no	1.6us	100ns	10ns	16.38us	2n	500MHz
6	no	3.2us	200ns	20ns	32.76us	4ns	250MHz
7	no	8us	500ns	50ns	81.92us	10ns	100MHz
8	yes	16us	1us	100ns	163.8us	20ns	50MHz
9	yes	32us	2us	200ns	327.6us	40ns	25MHz
10	yes	80us	5us	500ns	819.2us	100ns	10MHz
11	yes	160us	10us	1us	1.638ms	200ns	5MHz
12	yes	320us	20us	2us	3.276ms	400ns	2.5MHz
13	yes	800us	50us	5us	8.192ms	1us	1MHz
14	yes	1.6ms	100us	10us	16.38ms	2us	500kHz
15	yes	3.2ms	200us	20us	32.76ms	4us	250kHz
16	yes	8ms	500us	50us	81.92ms	10us	100kHz
17	yes	16ms	1ms	100us	163.8ms	20us	50kHz
18	yes	32ms	2ms	200us	327.6ms	40us	25kHz
19	yes	80ms	5ms	500us	819.2ms	100us	10kHz
20	yes	160ms	10ms	1ms	1.638s	200us	5kHz
21	yes	320ms	20ms	2ms	3.276s	400us	2.5kHz
22	yes	800ms	50ms	5ms	8.192s	1ms	1kHz
23	yes	1.6s	100ms	10ms	16.384s	2ms	500Hz

*Table 7.2.8.1. – M522 timebase ranges*

### 7.2.9. M523 timebase ranges

No	REAL TIME	t/div 1:8	t/div 1:1	t/div 10:1	ACQ. TIME	SAMP. PERIOD	SAMP. FREQ.
1	no	40ns	5ns	500ps	409.6ns	100ps	10GHz
2	no	80ns	10ns	1ns	8.196us	200ps	5GHz
3	no	160ns	20ns	2ns	1.638us	400ps	2.5GHz
4	no	400ns	50ns	5ns	4.096us	1n	1GHz
5	no	800ns	100ns	10ns	8.192us	2n	500MHz
6	no	1.6us	200ns	20ns	16.38us	4ns	250MHz
7	yes	4us	500ns	50ns	40.96us	10ns	100MHz

8	yes	8us	1us	100ns	81.96us	20ns	50MHz
9	yes	16us	2us	200ns	163.8us	40ns	25MHz
10	yes	40us	5us	500ns	409.6us	100ns	10MHz
11	yes	80us	10us	1us	819.2us	200ns	5MHz
12	yes	160us	20us	2us	1.638ms	400ns	2.5MHz
13	yes	400us	50us	5us	4.096ms	1us	1MHz
14	yes	800us	100us	10us	8.192ms	2us	500kHz
15	yes	1.6ms	200us	20us	16.38ms	4us	250kHz
16	yes	4ms	500us	50us	40.96ms	10us	100kHz
17	yes	8ms	1ms	100us	81.92ms	20us	50kHz
18	yes	16ms	2ms	200us	163.8ms	40us	25kHz
19	yes	40ms	5ms	500us	409.6ms	100us	10kHz
20	yes	80ms	10ms	1ms	819.2ms	200us	5kHz
21	yes	160ms	20ms	2ms	1.638s	400us	2.5kHz
22	yes	400ms	50ms	5ms	4.096s	1ms	1kHz
23	yes	800ms	100ms	10ms	8.192s	2ms	500Hz

*Table 7.2.9.1. – M523 timebase ranges*

### 7.2.10. M524 timebase ranges

No	REAL TIME	t/div 1:16	t/div 1:1	t/div 10:1	ACQ. TIME	SAMP. PERIOD	SAMP. FREQ.
1	no	80ns	5ns	500ps	819.2us	100ps	10GHz
2	no	160ns	10ns	1ns	1.638us	200ps	5GHz
3	no	320ns	20ns	2ns	3.276us	400ps	2.5GHz
4	no	800ns	50ns	5ns	8.192us	1n	1GHz
5	no	1.6us	100ns	10ns	16.38us	2n	500MHz
6	no	3.2us	200ns	20ns	32.76us	4ns	250MHz
7	yes	8us	500ns	50ns	81.92us	10ns	100MHz
8	yes	16us	1us	100ns	163.8us	20ns	50MHz
9	yes	32us	2us	200ns	327.6us	40ns	25MHz
10	yes	80us	5us	500ns	819.2us	100ns	10MHz
11	yes	160us	10us	1us	1.638ms	200ns	5MHz
12	yes	320us	20us	2us	3.276ms	400ns	2.5MHz
13	yes	800us	50us	5us	8.192ms	1us	1MHz
14	yes	1.6ms	100us	10us	16.38ms	2us	500kHz
15	yes	3.2ms	200us	20us	32.76ms	4us	250kHz
16	yes	8ms	500us	50us	81.92ms	10us	100kHz
17	yes	16ms	1ms	100us	163.8ms	20us	50kHz
18	yes	32ms	2ms	200us	327.6ms	40us	25kHz
19	yes	80ms	5ms	500us	819.2ms	100us	10kHz
20	yes	160ms	10ms	1ms	1.638s	200us	5kHz
21	yes	320ms	20ms	2ms	3.276s	400us	2.5kHz
22	yes	800ms	50ms	5ms	8.192s	1ms	1kHz
23	yes	1.6s	100ms	10ms	16.384s	2ms	500Hz

*Table 7.2.10.1. – M524 timebase ranges*

**7.2.11. M525 timebase ranges**

No	REAL TIME	t/div 1:10	t/div 1:1	t/div 10:1	ACQ. TIME	SAMP. PERIOD	SAMP. FREQ.
1	no	20ns	2ns	200ps	204.8ns	50ps	20GHz
2	no	50ns	5ns	500ps	512ns	125ps	8GHz
3	no	100ns	10ns	1ns	1.024us	250ps	4GHz
4	no	200ns	20ns	2ns	2.048us	500ps	2GHz
5	no	500ns	50ns	5ns	5.12us	1.25ns	800MHz
6	no	1us	100ns	10ns	10.24us	2.5ns	400MHz
7	yes	2us	200ns	20ns	20.48us	5ns	200MHz
8	yes	5us	500ns	50ns	51.2us	12.5ns	80MHz
9	yes	10us	1us	100ns	102.4us	25ns	40MHz
10	yes	20us	2us	200ns	204.8us	50ns	20MHz
11	yes	50us	5us	500ns	512ms	125ns	8MHz
12	yes	100us	10us	1us	1.024ms	250ns	4MHz
13	yes	200us	20us	2us	2.048ms	500ns	2MHz
14	yes	500us	50us	5us	5.12ms	1.25us	800kHz
15	yes	1ms	100us	10us	10.24ms	2.5us	400kHz
16	yes	2ms	200us	20us	20.48ms	5us	200kHz
17	yes	5ms	500us	50us	51.2ms	12.5us	80kHz
18	yes	10ms	1ms	100us	102.4ms	25us	40kHz
19	yes	20ms	2ms	200us	204.8ms	50us	20kHz
20	yes	50ms	5ms	500us	512ms	125us	8kHz
21	yes	100ms	10ms	1ms	1.024s	250us	4kHz
22	yes	200ms	20ms	2ms	4.096s	500us	2kHz
23	yes	500ms	50ms	5ms	10.24s	1.25ms	800Hz
24	yes	1s	100ms	10ms	20.48s	2.5ms	400Hz

*Table 7.2.11.1. – M525 timebase ranges***7.2.12. M526 timebase ranges**

No	REAL TIME	t/div 1:20	t/div 1:1	t/div 10:1	ACQ. TIME	SAMP. PERIOD	SAMP. FREQ.
1	no	40ns	2ns	200ps	409.6ns	50ps	20GHz
2	no	100ns	5ns	500ps	1.024us	125ps	8GHz
3	no	200ns	10ns	1ns	2.048us	250ps	4GHz
4	no	400ns	20ns	2ns	4.096us	500ps	2GHz
5	no	1us	50ns	5ns	10.24us	1.25ns	800MHz
6	no	2us	100ns	10ns	20.48us	2.5ns	400MHz
7	yes	4us	200ns	20ns	40.96us	5ns	200MHz
8	yes	10us	500ns	50ns	102.4us	12.5ns	80MHz
9	yes	20us	1us	100ns	204.8us	25ns	40MHz
10	yes	40us	2us	200ns	409.6us	50ns	20MHz
11	yes	100us	5us	500ns	1.024ms	125ns	8MHz
12	yes	200us	10us	1us	2.048ms	250ns	4MHz
13	yes	400us	20us	2us	4.096ms	500ns	2MHz
14	yes	1ms	50us	5us	10.24ms	1.25us	800kHz

15	yes	2ms	100us	10us	20.48ms	2.5us	400kHz
16	yes	4ms	200us	20us	40.96ms	5us	200kHz
17	yes	10ms	500us	50us	102.4ms	12.5us	80kHz
18	yes	20ms	1ms	100us	204.8ms	25us	40kHz
19	yes	40ms	2ms	200us	409.6ms	50us	20kHz
20	yes	100ms	5ms	500us	1.024s	125us	8kHz
21	yes	200ms	10ms	1ms	2.048s	250us	4kHz
22	yes	400ms	20ms	2ms	4.096s	500us	2kHz
23	yes	1s	50ms	5ms	10.24s	1.25ms	800Hz
24	yes	2s	100ms	10ms	20.48s	2.5ms	400Hz

*Table 7.2.12.1. – M526 timebase ranges*

### 7.3. M770 series performance characteristics

#### 7.3.1. Vertical deflection system

No of divisions	8
No of pixels per division	32
Deflection factor range	10mV/div to 5V/div in 1-2-5 sequence
Accuracy	+/- 2% of current value + 1 pixel
Resolution	8 bits (0,39%)
Frequency response (-3dB)	DC: 0 - 150 MHz, AC: 1.2Hz – 150 MHz
Step response rise time	max. 2.4 ns
Channel isolation	min. -60 dB
Resistance	1 MOhm +5 %, -2 %
Input resistance inaccuracy adjustment	Digital for absolute accuracy +/- 2% of current voltage + 1 pixel
Capacitance	28 pF +/- 1pF
Zero setting accuracy	+/- 2% of the screen
Maximum input voltage	+/- 200V at 100 kHz or less

*Table 7.3.1.1. – Vertical deflection system*

#### 7.3.2. Triggering

System type	Dual level
Trigger source for primary level	selectable Channel A, Channel B or external trigger input
Trigger source for secondary level	selectable Channel A, Channel B or external trigger input
Threshold setting	Channel A and Channel B on the whole display range. External fixed on about 1.5V
Slope selection	Leading or trailing edge independently on each source
Minimum trigger pulse period	5 ns
Minimum trigger pulse length	2.5 ns
Maximum voltage on external trigger input	-10V to +13V at 20 kHz or less
Adjustments	Digital filter with ability of setting the valid pulse length

	up to 131072*Ts for each level and counter of valid triggering events settable from 1 to 32768 for each level. HOLD-OFF settable up to 1048576*Ts with selectable AUTO mode, to sample proper amount of data before trigger. (Ts – actual real time sampling period)
--	--

**Table 7.3.2.1. – Triggering**

### 7.3.3. Data acquisition system

No of divisions	10
No of pixels per division	50
Mode of operation	Sampling before and after trigger with continual selection of the trigger position
Record length	settable from 1024 to 1048576 (1M) samples for each channel
Time base range in 1:1 mode	5 ns/d to 100 ms/d in 1-2-5 sequence
Time base range using different ZOOM modes	625 ps/d to 204.8 s/d
Time base accuracy	0.01 % to 100ns/d, 0.5 % for 50ns/d to 5 ns/d
Real time sampling frequency	500 Hz to 100 MHz
Equivalent sampling frequency	500 Hz to 10 GHz
Display range with respect to trigger event	1048576 samples before and 1048576 samples after trig. event in length of 1048576 samples

**Table 7.3.3.1. – Data acquisition system**

### 7.3.4. Probe compensation generator

Output connector	BNC, together with External trigger input
Output impedance	1 kOhm to parallel with 10nF and approx. 50 Ohm serial
Output waveform	Pulse with 1:1 duty cycle
Frequency	1465 Hz
Output voltage (no load)	3.3V +/- 5%

**Table 7.3.4.1. – Compensation generator**

### 7.3.5. Power

Power source	USB interface via USB cable (power ground isolated from ground of measuring inputs)
Max current	470mA

**Table 7.3.5.1. – Power**

### 7.3.6. Insulation specification

Maximum voltage between grounds	500Vp while the voltage [V] * frequency [Hz] factor must not exceed 50000 [V Hz]
Resistance	> 2 GOhm



Capacitance	cca 150pF
-------------	-----------

**Table 7.3.6.1. – Insulation specification****7.3.7. Mechanical characteristics**

Dimensions without feet and connectors	165 x 111 x 35 mm
Dimensions with feet and connectors	182 x 111 x 39 mm
Weight	550 g

**Table 7.3.7.1. – Mechanical characteristics****7.3.8. M774 timebase ranges**

No	REAL TIME	t/div 1:16	t/div 1:1	t/div 10:1	Max. ACQ. TIME	SAMP. PERIOD	SAMP. FREQ.
1	no	10.24us	5ns	500ps	102.4us	100ps	10GHz
2	no	20.48us	10ns	1ns	204.8us	200ps	5GHz
3	no	40.96us	20ns	2ns	409.6us	400ps	2.5GHz
4	no	102.4us	50ns	5ns	1.024ms	1n	1GHz
5	no	204.8us	100ns	10ns	2.048ms	2n	500MHz
6	no	409.6us	200ns	20ns	4.096ms	4ns	250MHz
7	yes	1.024ms	500ns	50ns	10.24ms	10ns	100MHz
8	yes	2.048ms	1us	100ns	20.48ms	20ns	50MHz
9	yes	4.096ms	2us	200ns	40.96ms	40ns	25MHz
10	yes	10.24ms	5us	500ns	102.4ms	100ns	10MHz
11	yes	20.48ms	10us	1us	204.8ms	200ns	5MHz
12	yes	40.96ms	20us	2us	409.6ms	400ns	2.5MHz
13	yes	102.4ms	50us	5us	1.024s	1us	1MHz
14	yes	204.8ms	100us	10us	2.048s	2us	500kHz
15	yes	409.6ms	200us	20us	4.096s	4us	250kHz
16	yes	1.024s	500us	50us	10.24s	10us	100kHz
17	yes	2.048s	1ms	100us	20.48s	20us	50kHz
18	yes	4.096s	2ms	200us	40.96s	40us	25kHz
19	yes	10.24s	5ms	500us	102.4s	100us	10kHz
20	yes	20.48s	10ms	1ms	204.8s	200us	5kHz
21	yes	40.96s	20ms	2ms	409.6s	400us	2.5kHz
22	yes	102.4s	50ms	5ms	1024s	1ms	1kHz
23	yes	204.8s	100ms	10ms	2048s	2ms	500Hz

**Table 7.3.8.1. – M774 timebase ranges****7.4. M595 performance characteristics****7.4.1. Vertical deflection system**

No of divisions	8
No of pixels per division	32
Deflection factor range	10mV/div to 5V/div in 1-2-5 sequence

Accuracy	+/- 2% of current value + 1 pixel
Resolution	8 bits (0,39%)
Frequency response (-3dB)	DC: 0-300 MHz, AC: 1.6 Hz-300 MHz for ranges 10mV/d to 50mV/d DC: 0-350 MHz, AC: 1.6 Hz-350 MHz for ranges 100mV/d to 5V/d
Step response rise time	max. 1.2 ns for ranges 10mV/d to 50mV/d max. 1 ns for ranges 100mV/d to 5V/d
Channel isolation	better than -40 dB
Resistance	1 MOhm +3 %, -1 %
Input resistance inaccuracy adjustment	Digital for absolute accuracy +/- 2% of current voltage + 1 pixel
Capacitance	28 pF +/- 1pF
Zero setting accuracy	+/- 2% of range
Maximum input voltage	+/- 200V at 100 kHz or less

**Table 7.4.1.1. – Vertical deflection system**

### 7.4.2. Triggering

System type	Dual level
Trigger source for primary level	Channel A, channel B or external trigger input
Trigger source for secondary level	Channel A, channel B or external trigger input
Threshold setting	Channel A and Channel B on the whole display range. External fixed on about 1.5V
Slope selection	Leading or trailing edge independently on each source
Minimum trigger pulse period	3 ns
Minimum trigger pulse length	1.5 ns
Maximum voltage on external trigger input	-10V to +13V at 20 kHz or less
Adjustments	Digital filter with ability of setting the valid pulse length up to 131072*Ts for each level and counter of valid triggering events settable from 1 to 32768 for each level. HOLD-OFF settable up to 1048576*Ts with selectable AUTO mode, to sample proper amount of data before trigger. (Ts – actual real time sampling period)

**Table 7.4.2.1. – Triggering**

### 7.4.3. Data acquisition system

No of divisions	10
No of pixels per division	50
Mode of operation	Sampling before and after trigger with continual selection of the trigger position
Record length	settable from 1024 to 32768 (32k) samples for each channel

Time base range in 1:1 mode	1 ns/div to 20 ms/div in 1-2-5 steps
Time base range using different ZOOM modes	125 ps/div to 1.28 s/div
Time base accuracy	0.01 % to 20ns/div, 0.5 % for 10ns/div to 1 ns/div
Real time sampling frequency	2500 Hz to 500 MHz dual channel mode 2500 Hz to 1 GHz single channel mode
Equivalent sampling frequency	2500 Hz to 50 GHz
Display range with respect to trigger event	32768 samples before and 32768 samples after trig. event in length of 32768 samples

**Table 7.4.3.1. – Data acquisition system**

#### 7.4.4. Probe compensation generator

Output connector	BNC, together with External trigger input
Output impedance	1 kOhm to parallel with 10nF and approx. 50 Ohm serial
Output waveform	Pulse with 1:1 duty cycle
Frequency	1465 Hz
Output voltage (no load)	3.3V +- 5%

**Table 7.4.4.1. – Probe compensation generator**

#### 7.4.5. Synchronization output

Output connector	BNC, together with External trigger input
Output waveform	Leading edge of about 3V high pulse

#### 7.4.6. Power

Power source	USB interface and auxiliary source 10V to 18V DC
Power Konsumption	USB: 0.85W (170mA), auxiliary: max. 7W

**Table 7.1.5.1. - Power**

#### 7.4.7. Mechanical characteristics

Dimensions without feet and connectors	165 x 111 x 35 mm
Dimensions with feet and connectors	182 x 111 x 39 mm
Weight	560 g

**Table 7.4.6.1. – Mechanical characteristics**

**7.4.8. Timebase ranges of M595**

No	REAL TIME	t/div 1:64	t/div 1:1	t/div 8:1	ACQ. TIME	SAMP. PERIOD	SAMP. FREQ.
1	no	64ns	1ns	125ps	-	20ps	50GHz
2	no	128ns	2ns	250ps	-	40ps	25GHz
3	no	320ns	5ns	625ps	-	100ps	10GHz
2	no	640ns	10ns	1.25ns	-	200ps	5GHz
3	no	1.28us	20ns	2.5ns	-	400ps	2.5GHz
4	yes for one channel	3.2us	50ns	6.25ns	32.768us	1n	1GHz
5	yes	6.4us	100ns	12.5ns	65.535us	2n	500MHz
6	yes	12.8us	200ns	25ns	131.07us	4ns	250MHz
7	yes	32us	500ns	62.5ns	327.68us	10ns	100MHz
8	yes	64us	1us	125ns	655.35us	20ns	50MHz
9	yes	128us	2us	250ns	1.3107ms	40ns	25MHz
10	yes	320us	5us	625ns	3.2768ms	100ns	10MHz
11	yes	640us	10us	1.25us	6.5535ms	200ns	5MHz
12	yes	1.28ms	20us	2.5us	13.107ms	400ns	2.5MHz
13	yes	3.2ms	50us	6.25us	32.768ms	1us	1MHz
14	yes	6.4ms	100us	12.5us	65.535ms	2us	500kHz
15	yes	12.8ms	200us	25us	131.07ms	4us	250kHz
16	yes	32ms	500us	62.5us	327.68ms	10us	100kHz
17	yes	16ms	1ms	100us	655.35ms	20us	50kHz
18	yes	128ms	2ms	250us	1.3107s	40us	25kHz
19	yes	320ms	5ms	625us	3.2768s	100us	10kHz
20	yes	640ms	10ms	1.25ms	6.5535s	200us	5kHz
21	yes	1.28s	20ms	2.5ms	13.107s	400us	2.5kHz

*Table 7.4.10.1. –M595 timebase ranges*

## 8. Other information

### 8.1. .esb format

The data in the .esb format are saved in binary form without compression. The file consists of the information block. The format of the block depends on its type. Following eight types are defined:

integer (integer)  
 floating-point (double)  
 integer array (intarray)  
 boolean array (boolarray)  
 floating-point array (doublearray)  
 fixed-length integer array (fintarray)  
 boolean (boolean)  
 acquired data (acqdata)

#### 8.1.1. Block structure

Each block starts with 8 bytes, which determine block length in bytes (32 bit value written in the first 4 bytes) and information about block contents (32 bit value written in the last 4 bytes). In case the block contains the information, which the application doesn't need, application can skip this block (by using the known block length).

Block structure is following:

##### *Integer*

4 bytes	4 bytes	4 bytes
block length (12)	information code	value

##### *Double*

4 bytes	4 bytes	8 bytes
block length (16)	information code	floating-point value (double)

##### *IntArray*

4 bytes	4 bytes	4 bytes	4 bytes	4*n bytes
block length	information code	array length (n)	array length 2 (n)	array contents

Array length and array length 2 must be the same. In case they are not, the file is corrupted.

##### *BoolArray*

4 bytes	4 bytes	4 bytes	4 bytes	n bytes
block length	information code	array length (n)	array length 2 (n)	array contents

Array length and array length 2 must be the same. In case they are not, the file is corrupted.

***DoubleArray***

4 bytes	4 bytes	4 bytes	4 bytes	8*n bytes
block length	information code	array length (n)	array length 2 (n)	array contents

Array length and array length 2 must be the same. In case they are not, the file is corrupted.

***FIntArray***

4 bytes	4 bytes	4 bytes	4 bytes
block length (16)	information code	first array item	second array item

***Boolean***

4 bytes	4 bytes	4 bytes
block length (12)	information code	boolean value (0 = false, 1 = true)

***AcqData***

4 bytes	4 bytes	4 bytes	4 bytes	-	...	-
block length	information code	channel count (n)	channel count 2 (n)	1-st channel data		n-th channel data

Channel count and channel count 2 must be the same. In case they are not, the file is corrupted.

The structure of the channel data is following:

4 bytes	4 bytes	n bytes
array length (n)	array length 2 (n)	array contents

Array length and array length 2 must be the same. In case they are not, the file is corrupted.

**8.1.2. Available information**

Following information are available in the file:

***MemorySize (Integer) – code 0***

Size of the memory used for data acquisition (in samples).

***Timebase (Double) – code 1***

Sampling rate used for data acquisition (in samples per second).

***Range (DoubleArray) – code 2***

Selected ranges (in mV per division). Array length corresponds with the channel count.

***Shift (IntArray) – code 3***

Vertical shift (0 is the maximal shift downwards, 4095 is the maximal shift upwards). Array length corresponds with the channel count. To determine the position of the 0V, use „GroundPos“ information.

***Filter (BoolArray) – code 4***

Indicates, whether the digital filter is on. Array length corresponds with the channel count.

***FilterFactor (IntArray) – code 5***

The digital filter level. Array length corresponds with the channel count.

***TriggerSrcOnPrimary (BoolArray) – code 6***

Indicates, whether the source is on/off (index 0 – channel A, 1 – channel B, 2 – external trigger input)

***TriggerSrcLeadingPrimary (BoolArray) – code 7***

Indicates, whether the triggering from the source is sensitive on the leading edge (index 0 – channel A, 1 – channel B, 2 – external trigger input).

***TriggerLevel (IntArray) – code 8***

The trigger threshold level (in quantization levels – from 0 to 255). Array length corresponds with the channel count.

***TriggerCount (FIntArray) – code 9***

The trigger count required to start acquisition on the trigger levels.

***TriggerLength (FIntArray) – code 10***

Minimal length of the valid trigger event (in samples).

***TriggerMode (Integer) – code 11***

The trigger mode (0 – Auto, 1 – Normal, 2 – Single, 3 – Manual).

***AfterTriggerSamples (Integer) – code 12***

Amount of samples acquired after trigger event.

***HoldOffSamples (Integer) – code 13***

Hold-off length in samples.

***ProbeMode (IntArray) – code 14***

The probe attenuation (0 – 1:1, 1 – 1:10, 2 – 1:100, 3 – 1:1000). Array length corresponds with the channel count.

***Ground (BoolArray) – code 15***

Indicates, whether the grounding is on. Array length corresponds with the channel count.

***DC (BoolArray) – code 16***

Indicates, whether the DC coupling is on. Array length corresponds with the channel count.

***GroundPos (DoubleArray) – code 17***

Position of the 0V on the screen (in quantization levels – from 0 to 255). Array length corresponds with the channel count.

***AcquiredData (AcqData) – code 18***

The data measured on the channels (together with virtual channels).

***Version (Integer) – code 19***

File version (currently set to zero).

***FirstValidSamples (IntArray) – code 20***

Index of the first valid sample in the channel data.

***LastValidSamples (IntArray) – code 21***

Index of the last valid sample in the channel data.

***TriggerSrcOnSecondary (BoolArray) – code 22***

Indicates triggering on the secondary level from source (index 0 – channel A, 1 – channel B, 2 – external trigger input).

***TriggerSrcLeadingSecondary (BoolArray) – code 23***

Indicates, whether the triggering from the source is sensitive on the leading edge (index 0 – channel A, 1 – channel B, 2 – external trigger input).

***ATMode (Integer) – code 24***

After trigger count mode (0 – HSC, 1 – FSC, 2 – Set, 3 – Min).

***HFMode (Integer) – code 25***

Hold-off mode (0 – Auto, 1 – Set).

***SimpleTrigger (Bool) – code 26***

Indicates „Simple“ mode of the trigger system.

***WCDSensitivity (Integer) – code 27***

Indicates WCD sensitivity. Value 255 indicates WCD switched off, 0 indicates the biggest sensitivity.



## 8.2. Command lines parameters

There are several command line parameters available for the Scope application. You just have to add parameter to the icon target in the icon properties (change target for example from "C:\Program Files\ETC\Scope\scope.exe" to "C:\Program Files\ETC\Scope\scope.exe" -s "c:\program files\ETC\Scope\Settings\default.st").

### 8.2.1. Selecting settings loaded on the application start

Parameter `-s` allows you to select the settings file, that will be used during application start. This file is not overwritten on the application exit, so the application always start with same settings.

**Syntax:** `scope.exe -s "<settings file name>"`

**Example:** `"C:\Program Files\ETC\Scope\scope.exe" -s "c:\program files\ETC\Scope\Settings\default.st"`

The example uses the settings from the `c:\program files\ETC\Scope\Settings\default.st` file. The settings file can be created by selecting *Settings / Save settings* from main menu.

### 8.2.2. Selecting the type of the used device

Parameter `-d` allows you to select the device type. The devices of other type will be ignored during initialization.

**Syntax:** `scope.exe -d <device type>`

**Example:** `"C:\Program Files\ETC\Scope\scope.exe" -d 570`

The example searches for and initializes only the M574 oscilloscope. Allowed device types are following:

Parameter	Device type
520	M521, M522, M523, M524, M525, M526
570	M574
770	M774
590	M595

*Table 8.2.2.1. – Allowed device types of `-d` parameter*